

P R E C I S I O N



Ophthalmic Surgical Instruments

John Weiss & Son Ltd has built its reputation on the ability to invent and manufacture instruments based on the ideas and requests of surgeons worldwide.

The Company's origins extend back to the 18th Century when John Weiss left Austria for London, forming the Company in 1787. His skills as a Master Cutler and Instrument Maker were soon widely acclaimed, and he received much recognition for his innovation and craftsmanship, including the award of a Royal Warrant as 'Razor Maker' to King William IV.

From the original London showroom and workshops to its present location in Milton Keynes, the company has strived to adapt and evolve to the ever changing needs and demands of the modern surgeon and continues to be the leading brand domestically, while successfully exporting to over 40 countries worldwide. Now with the international backing of the Haag-Streit Group of companies, the product range has expanded to over 2500 products encompassing all subspecialties of Ophthalmic Surgery; cataract, corneal, oculoplastic, glaucoma and vitreoretinal, as well as veterinary. John Weiss is also able to provide a range of Middle Ear Surgery instruments.

www.johnweiss.com

John Weiss & Son Ltd

23 Shenley Pavilions, Chalkdell Drive, Shenley Wood, Milton Keynes MK5 6LB
Tel: +44(0)1908 340000 Fax: +44(0)1908 340014 Email: sales@johnweiss.com



Forceps

Moorfields, non toothed / tying, notched, toothed, Capsulorhexis, Colibri, Cilia, Muscle/Strabismus, Lens, Artery, towel clamps, specialist

Needle Holders

Curved and straight, with or without catch

Scissors

Spring, bow / ribbon. De Wecker, Vannas, Westcott, Williamson-Noble, Corneal, Capsulotomy, Strabismus, Stevens tenotomy, specialist, utility

Choppers & Manipulators

Choppers & Splitters, Manipulators, Spatula / Repositors, Double ended combinations, Hooks, Vectis

Specula

Adjustable or Non-adjustable Infant and Adult

Extraocular

Lid Chalazion and Cyst, Ptosis, Entropion / Ectropion, Strabismus. Lacrimal probes & dilators, Lester Jones Tubes, DCR punches & intubation sets. Retractors & Hooks. Chisels & Osteotomes. Orbital instruments & implants. Enucleation / Evisceration.

Specialist

General, Vitreoretinal, Corneal and Refractive, Cataract, Glaucoma, Diamond Knives, Corneal knives, Trephines, Trays.
Veterinary: Ophthalmic, Exotic & small animal

Single use

Cannulae, Drapes, Sponges, wipes & wicks, Eye shields and patches, cautery

See overleaf for a guide on how to use this catalogue

A brief guide on how to use this catalogue

The pages within this catalogue have been designed to help you learn more about our products and their specifications.

Please use the pdf bookmarks on the left to navigate to the correct section.

To find a specific word or product code when using Adobe Acrobat or Reader, select Edit > Find from the application menu.

Example of product detail

Product code number – please specify this number when ordering.

Indicates material used to manufacture product: **SS** for stainless steel **Ti** for titanium.

0101562 **SS**

Capsulorhexis forceps, round body with standard tips. Standard shaft, 12mm tip to angle, overall length 103mm

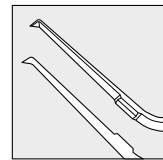

Description detailing product physical specification alongside product image.

Please note: images are not shown at actual size.

Illustration of the tip detail if required.

NOTE: a product analysis is also included on the following page of some section dividers to help you to understand product parts in more detail.

Product care

Advice on how to care for your product(s) can be found on the Instrument Care page. For the most up-to-date information on how to look after your instruments please refer to the John Weiss website www.johnweiss.com

Repairs

Utilising the skills of the instrument maker, John Weiss provides a repair service for damaged or blunt microsurgical instruments. For more information please contact us on +44(0)1908 340000 or email: sales@johnweiss.com

John Weiss & Son Ltd reserve the right to change specifications without notice.

Forceps

Moorfields, non toothed/tying, notched, toothed, Capsulorhexis, Colibri, Cilia, Muscle/Strabismus, Lens, Artery, towel clamps, specialist



Forceps form an extension of the surgeons fingers enabling secure handling of tissue, suture, intraocular lens etc. They can be used to grasp, hold, pull/push, lift, or tear depending on the tip design and application.

Forceps anatomy

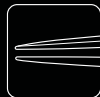
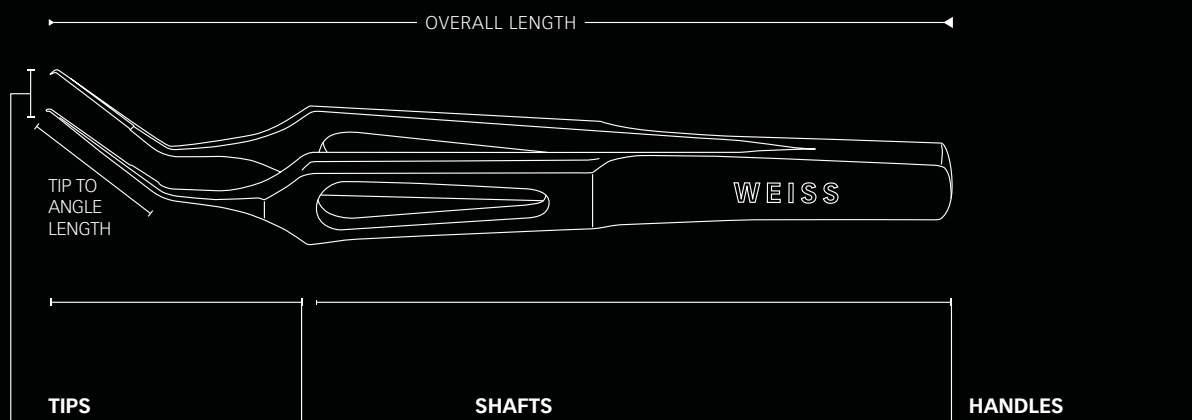

Plain –
general purpose –
removing sutures

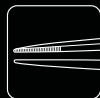

Serrated –
general purpose –
grasping tissue (atraumatic)

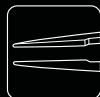

Platform –
for holding, tying and
removing sutures

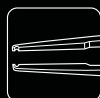

Notched –
for grasping and holding
tissue (atraumatic),
tying sutures (platform)

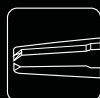

Toothed –
for grasping and holding
tissue including muscle,
tying sutures (platform)

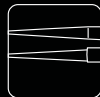

Straight –
for when access is direct



Curved –
for when access
is restricted



Angled –
for when access
is restricted



Colibri –
for good visualisation
and positioning of tip



Cross action –
for maximum opening of tip
within small incision



Formed –
accommodates natural
curvature of crystalline lens



Flat – for good manual grip
and control of the tip but may
require significant hand, wrist
or forearm movement



Round – rotating handle by
rolling between fingers allows
for 'micro' control of the tip
with minimum movement



Cross action – opens and
closes tips by asserting and
releasing pressure – offering
'micro' control

Forceps – non toothed

Moorfields

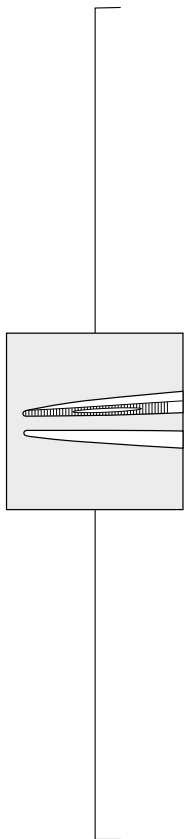

0101542 **SS**

Moorfields forceps, straight with standard serrated tips. 14mm platform, overall length 113mm



0109015 **Ti**

Moorfields forceps, straight with standard serrated tips. 14mm platform, overall length 113mm



0101543 **SS**

Moorfields forceps, straight with fine serrated tips. 14mm platform, overall length 113mm



0109021 **Ti**

Moorfields forceps, straight with fine serrated tips. 14mm platform, overall length 113mm



0101544 **SS**

Moorfields Skov forceps angled with standard tips. 14mm platform, 15mm tips to angle, overall length 110mm

Forceps – non toothed, tying

Plain

0109030 **Ti**

Weiss slimline forceps, straight with plain tips, overall length 85mm



0109024 **Ti**

Weiss forceps, straight with plain tips, overall length 85mm



0101166 **ss**

Hoskins forceps No.17, straight with plain 0.5mm tips, overall length 93mm



0101179 **ss**

Hoskins forceps No.32, straight with plain 0.3mm tips, overall length 88mm



0101181 **ss**

Hoskins No 34 Colibri forceps with fine pointed plain tips, no platform, overall length 86mm



0109428 **Ti**

Ring tipped forceps, atraumatic. Straight with 1.2mm ring and 0.6mm hole, overall length 108mm

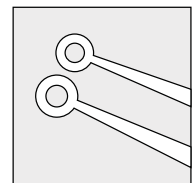
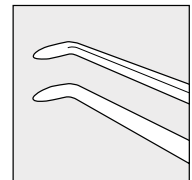
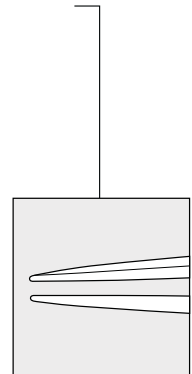

Forceps – non toothed, tying

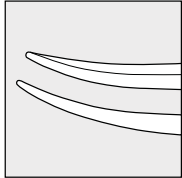

0101008 **SS**

Max Fine forceps, curved with plain tips, overall length 110mm



0109422 **Ti**

Max Fine forceps, curved with plain tips, overall length 110mm

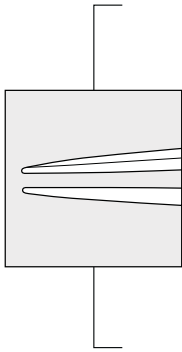

0101373 **SS**

Jewellers forceps No.3, straight with plain, medium size tips, overall length 126mm



0101375 **SS**

Jewellers forceps No.4, straight with plain, fine tips, overall length 106mm



0101372 **SS**

Jewellers forceps No.5, straight with plain, ultra fine tips, overall length 115mm

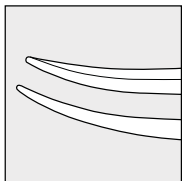

0101374 **SS**

Jewellers forceps No.7, curved with plain tips, overall length 115mm

Forceps – non toothed, tying

Serrated

0101315 **SS**

Iris forceps, straight with 12mm serrated tips, overall length 99mm



0101323 **SS**

Graefe forceps straight with 12mm serrated tips, overall length 100mm



0204132 **SS**

Adson forceps, straight with 10mm serrated tips, overall length 122mm



0101324 **SS**

Graefe forceps curved, with 10mm serrated tips, overall length 93mm



0101313 **SS**

Iris forceps, 25° curved with 10mm serrated tips, overall length 99mm



0101314 **SS**

Iris forceps, 60° curved with 10mm serrated tips, overall length 99mm

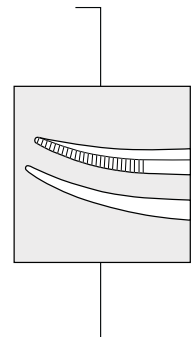
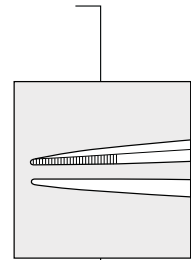

Forceps – non toothed, tying

Platform

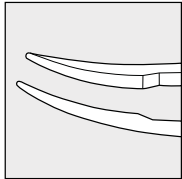

4mm Platform

0109075 Ti

Weiss slimline forceps, curved with 4mm platform, overall length 83mm



0109073 Ti

Weiss slimline forceps, delicate tips, curved with 4mm platform, overall length 83mm

5mm Platform

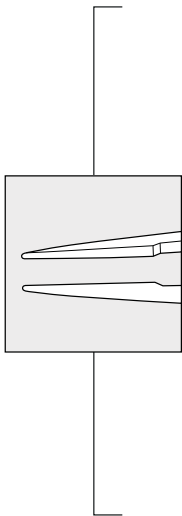

0101103 SS

Birks forceps, straight with 5mm platform, overall length 105mm



0109142 Ti

Birks forceps, straight with 5mm platform, overall length 109mm



0109035 Ti

Weiss slimline forceps, straight with 5mm platform, overall length 85mm



0109026 Ti

Weiss forceps, straight with 5mm platform, overall length 85mm

Forceps – non toothed, tying

Platform

5mm Platform continued

0101018 **SS**
Harms forceps, straight with 5mm platform,
0.5mm tips, overall length 101mm

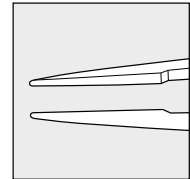

0101020 **SS**
Harms-Jaffe forceps, straight with 5mm platform,
0.3mm tips, overall length 101mm



0109064 **Ti**
Weiss Colibri forceps with 5mm platform,
overall length 86mm

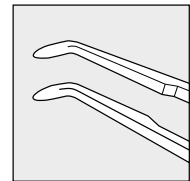

0101365 **SS**
Colibri forceps with 5mm platform,
overall length 78mm



0101105 **SS**
Birks forceps, curved with 5mm platform,
overall length 105mm

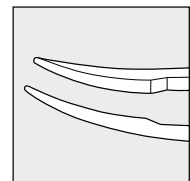

0109143 **Ti**
Birks forceps, curved with 5mm platform,
overall length 109mm



Forceps – non toothed, tying

Platform

6mm Platform

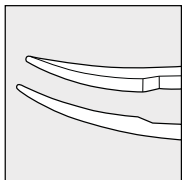
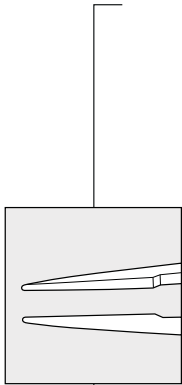

0101006 SS

Stallard forceps, straight with 6mm platform, overall length 111mm



0109152 Ti

Birks forceps, straight with 6mm platform, ultra fine tips, overall length 109mm



0101015 SS

Castroviejo wide handle forceps, straight with 6mm platform, delicate tips, overall length 105mm



0101010 SS

Catford forceps, straight with 6mm platform, overall length 73mm



0109420 Ti

Castroviejo forceps, straight with 6mm platform, delicate tips, overall length 110mm



0109421 Ti

Castroviejo forceps, curved with 6mm platform, delicate tips, overall length 110mm



0101019 SS

Harms forceps, curved with 6mm platform, overall length 100mm



0101021 SS

Harms-Jaffe forceps, curved with 6mm platform, overall length 100mm

Forceps – non toothed, tying

Platform

7mm Platform continued

0101017 **SS**
 McPherson forceps, straight with 7mm platform, overall length 89mm



0101009 **SS**
 Rycroft forceps, straight with 7mm platform, overall length 103mm



0101011 **SS**
 McPherson forceps, angled with 7mm platform, 7.5mm tip to angle, overall length 91mm



0109097 **Ti**
 McPherson forceps, angled with 7mm platform, 7.0mm tip to angle, overall length 85mm



0109149 **Ti**
 Birks forceps, angled with 7mm platform, 7.5mm tip to angle, overall length 106mm



0109096 **Ti**
 McPherson forceps, angled with 7mm platform, 10mm tip to angle, overall length 80mm



0109098 **Ti**
 McPherson forceps, angled with 7mm platform, 12mm tip to angle, overall length 81mm



0109091 **Ti**
 McPherson forceps, angled on flat with 7mm platform, 12mm tip to angle, overall length 85mm



NOTE: this forcep opens top to bottom

0109435 **Ti**
 Kelman-McPherson forceps, angled with 7.5mm platform, 9mm tip to angle, overall length 108mm

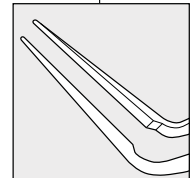
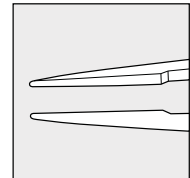

Forceps – non toothed, tying

Platform

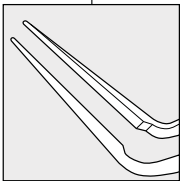
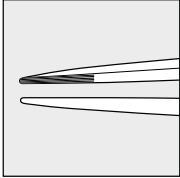

8mm Platform



0101003 SS

Alabama forceps, straight with 8mm platform and longitudinal serrations, overall length 101mm

10mm Platform



0101013 SS

Kelman-McPherson forceps, angled with 10mm platform, 10.5mm tip to angle, overall length 88mm



0109433 Ti

Kelman-McPherson forceps, angled with 10mm platform, 10.5mm tip to angle, overall length 103mm



0109148 Ti

Birks forceps, angled with 10mm platform, 10.5mm tip to angle, overall length 106mm

12mm Platform



0101014 SS

Kelman-McPherson forceps, angled with 12mm platform, 12.5mm tip to angle, overall length 88mm



0109434 Ti

Kelman-McPherson forceps, angled with 12mm platform, 12.5mm tip to angle, overall length 103mm

Forceps – notched

0109028 **Ti**

Weiss slimline forceps, straight with a 0.25mm notch, 4mm platform, overall length 85mm



0109023 **Ti**

Weiss forceps, straight with a 0.25mm notch, 3mm platform, overall length 85mm



0109427 **Ti**

Castroviejo forceps, straight with a 0.25mm notch, 6mm platform, overall length 110mm



0109072 **Ti**

Weiss forceps, curved with a 0.25mm notch, 4mm platform, overall length 83mm



0109150 **Ti**

Birks forceps, angled with a 0.25mm notch, 7mm platform, 8mm tip to angle, overall length 106mm



0101012 **ss**

McPherson forceps, angled with a 0.3mm notch, 7mm platform, 7.5mm tip to angle, overall length 91mm



0109431 **Ti**

McPherson forceps, angled with a 0.3mm notch, 7mm platform, 7mm tip to angle, overall length 108mm

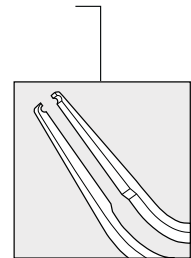
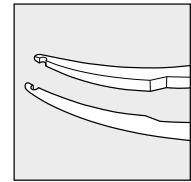
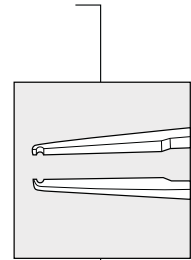

Forceps – notched

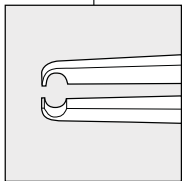
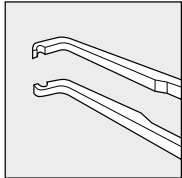

0109147 **Ti**

Birks Colibri forceps, with a 0.25mm notch, 4mm platform, overall length 108mm



0109063 **Ti**

Weiss Colibri Forceps, with a 0.25mm notch, 5mm platform, overall length 86mm



0101162 **SS**

Hoskins No.10 forceps, straight with a 0.8mm notch, overall length 93mm



0101163 **SS**

Hoskins No.11 forceps, straight with a 0.5mm notch, overall length 93mm



0101164 **SS**

Hoskins No. 15 forceps, straight with a 0.3mm notch, overall length 93mm



0101176 **SS**

Hoskins No.28 forceps, straight with a 0.25mm notch, overall length 88mm



0101168 **SS**

Hoskins No.19 forceps, straight with a 0.3mm notch, overall length 88mm



0101167 **SS**

Hoskins No. 18 forceps, straight with a 0.5mm notch, overall length 88mm

Forceps – toothed

0.1mm teeth

0109036 **Ti**

Weiss slimline forceps, straight with 0.1mm forward facing teeth, 5mm platform, overall length 85mm



0109065 **Ti**

Weiss Colibri forceps, with 0.1mm forward facing teeth, 5mm platform, overall length 85mm

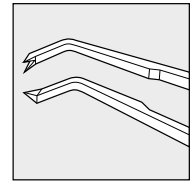
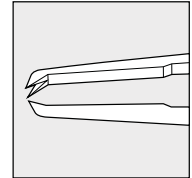

0.12mm teeth

0101107 **SS**

Birks forceps, straight with 0.12mm teeth, 5mm platform, overall length 105mm



0109144 **Ti**

Birks forceps, straight with 0.12mm teeth, 5mm platform, overall length 109mm



0101075 **SS**

Bonn forceps, straight with 0.12mm teeth, 6mm platform, overall length 115mm



0109013 **Ti**

Bonn forceps, straight with 0.12mm teeth, 6mm platform, overall length 111mm



0109012 **Ti**

Jayle forceps, straight with 0.12mm teeth, 6mm platform, overall length 118mm



0109014 **Ti**

Bonn forceps, straight with 0.12mm teeth, overall length 72mm



0101332 **SS**

Bonn forceps straight with 0.12mm teeth, overall length 72mm

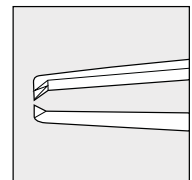
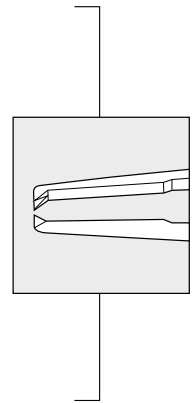

Forceps – toothed

0.12mm teeth

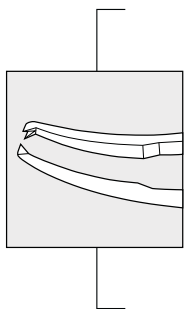
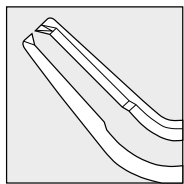
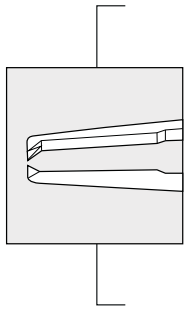

0109029 Ti

Weiss slimline forceps, straight with 0.12mm teeth, 4mm platform, overall length 85mm



0109025 Ti

Weiss forceps, straight with 0.12mm teeth, 5mm platform, overall length 85mm



0109424 Ti

Castroviejo forceps, straight with 0.12mm teeth, 6mm platform, overall length 110mm



0109095 Ti

McPherson forceps, angled with 0.12mm teeth, 7mm platform, 14mm tip to angle, overall length 83mm



0109151 Ti

Birks forceps, angled with 0.12mm teeth, 10mm platform, 10.5mm tip to angle, overall length 106mm



0101109 SS

Birks forceps, curved with 0.12mm teeth, 5mm platform, overall length 105mm



0109145 Ti

Birks forceps, curved with 0.12mm teeth, 5mm platform, overall length 109mm



0109074 Ti

Weiss forceps, curved with 0.12mm teeth, 5mm platform, overall length 83mm

Forceps – toothed

0.12mm teeth continued

0101111 **SS**
 Birks Colibri forceps with 0.12mm teeth,
 5mm platform, overall length 105mm



0109146 **Ti**
 Birks Colibri forceps with 0.12mm teeth,
 4mm platform, overall length 107mm



0101079 **SS**
 Castroviejo Colibri forceps with 0.12mm teeth,
 5mm platform, overall length 105mm



0109423 **Ti**
 Castroviejo Colibri wide handle forceps with
 0.12mm teeth, 5mm platform, overall length
 110mm



0101364 **SS**
 Colibri forceps with 0.12mm teeth,
 6mm platform, overall length 74mm



0109062 **Ti**
 Weiss Colibri forceps with 0.12mm teeth,
 5mm platform, overall length 86mm



0101074 **SS**
 Castroviejo forceps, straight with 0.12mm forward
 facing teeth, 8mm platform, overall length 113mm



0101078 **SS**
 Castroviejo wide handle forceps, straight with
 0.12mm forward facing teeth, 6mm platform,
 overall length 105mm



0109070 **Ti**
 Polack Colibri forceps, 2 pronged for corneal
 suturing with 0.12mm teeth, 4.5mm platform,
 overall length 75mm

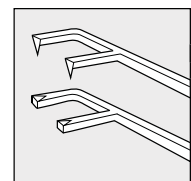
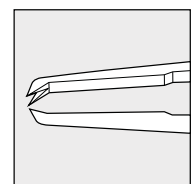
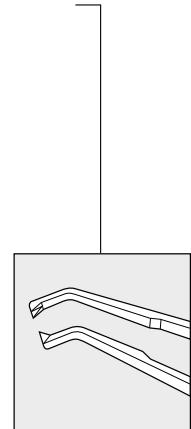

Forceps – toothed

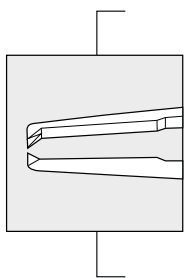
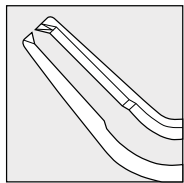
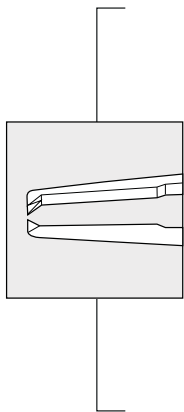

0.15mm teeth

0101072 SS

Jayle forceps, straight with 0.15mm teeth, 6mm platform, overall length 118mm



0101073 SS

St.Martin forceps, straight with 0.15mm teeth, 6mm platform, overall length 87mm



0109162 Ti

St.Martin forceps, straight with 0.15mm teeth, 5mm platform, overall length 88mm



0101076 SS

Catford forceps, straight with 0.15mm teeth, 4mm platform, overall length 70mm



0101077 SS

McPherson forceps, angled with 0.15mm teeth, 7mm platform, 7.5mm tip to angle, overall length 91mm



0.3mm teeth

0101045 SS

Rycroft forceps, straight with 0.3mm teeth, 8mm platform, overall length 104mm



0101042 SS

Jayle forceps, straight with 0.3mm teeth, 6mm platform, overall length 118mm



0109011 Ti

Jayle forceps, straight with 0.3mm teeth, 6mm platform, overall length 115mm

Forceps – toothed

0.3mm teeth continued

0101043 **SS**
St.Martin forceps, straight with 0.3mm teeth,
6mm platform, overall length 87mm



0109172 **Ti**
St.Martin forceps, straight with 0.3mm teeth,
5mm platform, overall length 88mm



0101049 **SS**
Castroviejo forceps, straight with 0.3mm teeth,
6mm platform, overall length 99mm



0109425 **Ti**
Castroviejo forceps, straight with 0.3mm teeth,
6mm platform, overall length 110mm



0101050 **SS**
Castroviejo forceps, straight with 0.3mm teeth,
6mm platform, overall length 99mm



0109180 **Ti**
Birks forceps, curved with 0.3mm teeth,
5mm platform, overall length 109mm



0101362 **SS**
Colibri forceps with 0.3mm teeth, overall length
74mm



0101363 **SS**
Colibri forceps with 0.3mm teeth, 5mm platform,
overall length 74mm



0101046 **SS**
Castroviejo wide handle forceps, straight with
0.3mm forward facing teeth, 8mm platform,
overall length 105mm

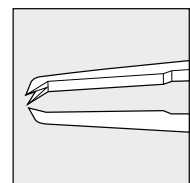
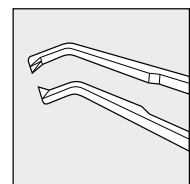
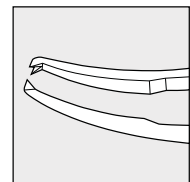
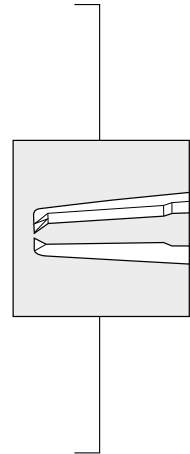

Forceps – toothed

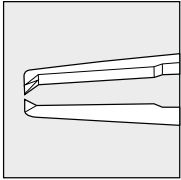

0.5mm teeth

0109426 **Ti**

Castroviejo forceps, straight with 0.5mm teeth, 6mm platform, overall length 110mm

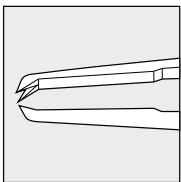

0101047 **SS**

Castroviejo wide handle forceps, straight with 0.5mm forward facing teeth, 8mm platform, overall length 105mm

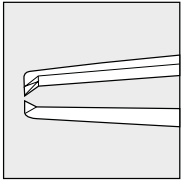

0204134 **SS**

Adson forceps, straight with 0.5mm teeth, overall length 122mm

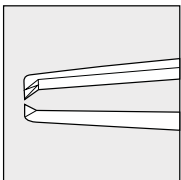

0.75mm teeth

0101318 **SS**

Graefe forceps, straight with 0.75mm teeth, overall length 73mm

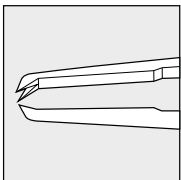

0.9mm teeth

0101048 **SS**

Castroviejo wide handle forceps, straight with 0.9mm forward facing teeth, 8mm platform, overall length 105mm

Forceps – toothed

Fixation

0101284 **SS**

Weiss fixation forceps, straight with 1mm teeth (1 into 2), overall length 115mm

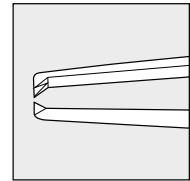

0101285 **SS**

Francis fixation forceps, straight with 1mm teeth (2 into 3), overall length 120mm



0101298 **SS**

Graefe locking fixation forceps, straight with 4mm wide tip, 6 x 0.7mm teeth, overall length 110mm



0101005 **SS**

Lister forceps, straight with 1.2mm forward facing teeth, 12mm platform, overall length 110mm

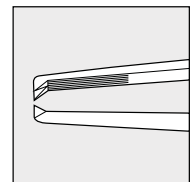

0101290 **SS**

Elschnig forceps, straight with 1.2mm teeth (1 into 2), overall length 109mm

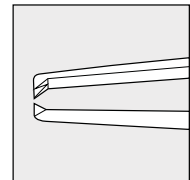

Forceps – Capsulorhexis

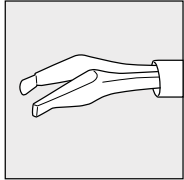

For incision size 1mm - 1.8mm

2003100 Ti

23G, curved, capsulorhexis forceps, end grasping for sub 1mm incision, overall length 140mm

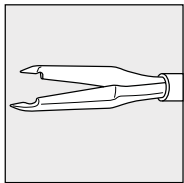

2003102 Ti

Gutierrez-C combination curved 23G capsulorhexis forceps/scissors for sub 1mm incision. 0.3mm end grasping forcep lies in front of straight scissor with 2.0mm vertical cutting blade, overall length 140mm

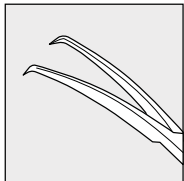

0109081 Ti

Cross action capsulorhexis forceps with sharp tips. Formed shaft, 14mm tip to angle, overall length 105mm



0109083 Ti

Cross action round body forceps with sharp tips. Formed shaft, 14mm tip to angle, overall length 115mm

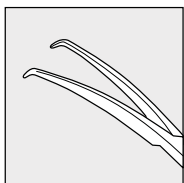

0109082 Ti

Cross action capsulorhexis forceps with round tips. Formed shaft, 14mm tip to angle, overall length 105mm

Forceps – Capsulorhexis

For incision size 2mm - 2.5mm

0101569 **SS**

Capsulorhexis forceps, round body with ultrafine tips. Formed shaft, 9mm tip to angle, overall length 104mm



0101570 **SS**

Capsulorhexis forceps, wide body with ultrafine tips. Formed shaft, 10mm tip to angle, overall length 105mm



0109136 **Ti**

Weiss capsulorhexis forceps with ultrafine, serrated tips and 1mm markings along shaft. Formed shaft, 14mm tip to angle, overall length 80mm

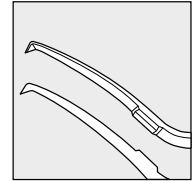

For incision size 2.5mm - 2.8mm

0109127 **Ti**

Inamura round bodied, cross action capsulorhexis forceps with fine tapered tips. Formed shaft, 14mm tip to angle, overall length 110mm



0109129 **Ti**

Inamura round bodied, cross action capsulorhexis forceps with fine tapered tips. Formed shaft, 13mm tip to angle, overall length 110mm

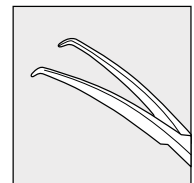

For incision size 2.8mm+ - with formed shaft

0101563 **SS**

Capsulorhexis forceps, round body with standard tips. Formed shaft, 12mm tip to angle, overall length 103mm







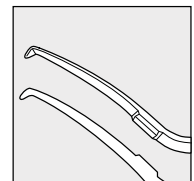

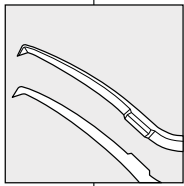

0109122 **Ti**

Capsulorhexis forceps, round body with fine tips. Formed shaft, 12mm tip to angle, overall length 105mm

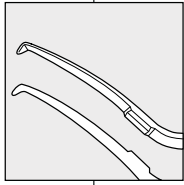

Forceps – Capsulorhexis

For incision size 2.8mm+ - with formed shaft

| | | |
|---|--|--|
|  |  | 0109123 Ti Capsulorhexis forceps, round body with sharp tips. Formed shaft, 12mm tip to angle, overall length 105mm |
| |  | 0109445 Ti Utrata capsulorhexis forceps with sharp tips. Formed shaft, 12mm tip to angle, overall length 104mm |
| |  | 0109117 Ti Weiss capsulorhexis forceps with sharp tips. Formed shaft, 12mm tip to angle, overall length 108mm |
| |  | 0109119 Ti Cross action capsulorhexis forceps with sharp tips. Formed shaft, 12mm tip to angle, overall length 108mm |
|  |  | 0109438 Ti Utrata capsulorhexis forceps with fine tips. Formed shaft, 12mm tip to angle, overall length 104mm |
| |  | 0101565 SS Capsulorhexis forceps, wide body with standard tips. Formed shaft, 12mm tip to angle, overall length 105mm |
| |  | 0109113 Ti Weiss capsulorhexis forceps with fine tips. Formed shaft, 12mm tip to angle, overall length 108mm |
| |  | 0109115 Ti Cross action capsulorhexis forceps with fine tips. Formed shaft, 12mm tip to angle, overall length 108mm |

Forceps – Capsulorhexis

For incision size 2.8mm+ - with standard shaft

0109135 **Ti**

Weiss slimline capsulorhexis forceps with sharp, serrated tips. Standard shaft, 14mm tip to angle, overall length 80mm



0109444 **Ti**

Utrata capsulorhexis forceps with sharp tips. Standard shaft, 12mm tip to angle, overall length 104mm



0109120 **Ti**

Capsulorhexis forceps, round body with sharp tips. Standard shaft, 12mm tip to angle, overall length 105mm



0101562 **SS**

Capsulorhexis forceps, round body with standard tips. Standard shaft, 12mm tip to angle, overall length 103mm



0109121 **Ti**

Capsulorhexis forceps, round body with fine tips. Standard shaft, 12mm tip to angle, overall length 103mm



0109131 **Ti**

Weiss slimline capsulorhexis forceps with standard, serrated tips. Standard shaft, 14mm tip to angle, overall length 80mm



0109437 **Ti**

Utrata capsulorhexis forceps with fine tips. Standard shaft, 12mm tip to angle, overall length 104mm

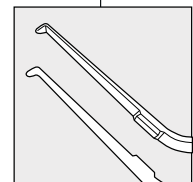
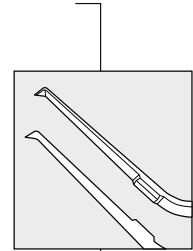

Forceps – Capsulorhexis

For incision size 2.8mm+ - with standard shaft

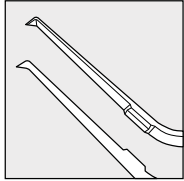

0109116 Ti

Weiss capsulorhexis forceps with sharp tips. Standard shaft, 12mm tip to angle, overall length 108mm



0109118 Ti

Cross action capsulorhexis forceps with sharp tips. Standard shaft, 12mm tip to angle, overall length 108mm



0101564 SS

Capsulorhexis forceps, wide body with standard tips. Standard shaft, 12mm tip to angle, overall length 106mm



0109112 Ti

Weiss capsulorhexis forceps with fine tips. Standard shaft, 12mm tip to angle, overall length 108mm



0109114 Ti

Cross action capsulorhexis forceps with fine tips. Standard shaft, 12mm tip to angle, overall length 108mm

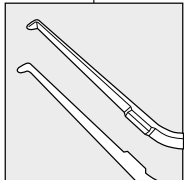

Forceps – Colibri

0101181 **SS**

Hoskins No 34 Colibri forceps with fine pointed plain tips, no platform, overall length 86mm

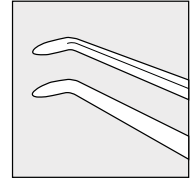

0101362 **SS**

Colibri forceps with 0.3mm teeth, no platform, overall length 74mm

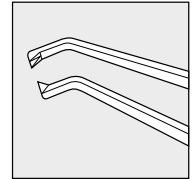

0109147 **Ti**

Birks Colibri forceps, with a 0.25mm notch, 4mm platform, overall length 108mm

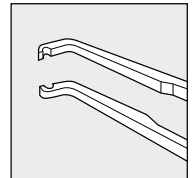

0109063 **Ti**

Weiss Colibri forceps, with a 0.25mm notch, 5mm platform, overall length 86mm

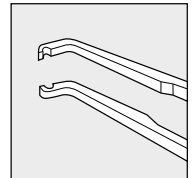

0109064 **Ti**

Weiss Colibri forceps with 5mm platform, overall length 86mm

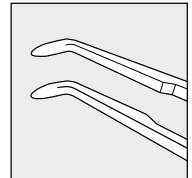

0101365 **SS**

Colibri forceps with 5mm platform, overall length 78mm

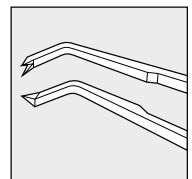

0109065 **Ti**

Weiss Colibri forceps, with 0.1mm forward facing teeth, 5mm platform, overall length 85mm

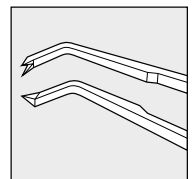

0109070 **Ti**

Polack Colibri forceps, 2 pronged for corneal suturing with 0.12mm teeth, 4.5mm platform, overall length 75mm

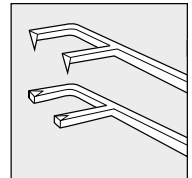

Forceps – Colibri

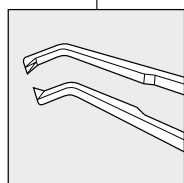

0101079 SS

Castroviejo Colibri wide handle forceps with 0.12mm teeth, 5mm platform, overall length 105mm



0109423 Ti

Castroviejo Colibri wide handle forceps with 0.12mm teeth, 5mm platform, overall length 110mm



0101364 SS

Colibri forceps with 0.12mm teeth, 6mm platform, overall length 74mm



0109062 Ti

Weiss Colibri forceps with 0.12mm teeth, 5mm platform, overall length 86mm



0101363 SS

Colibri forceps with 0.3mm teeth, 5mm platform, overall length 74mm



0101111 SS

Birks Colibri forceps with 0.12mm teeth, 5mm platform, overall length 105mm



0109146 Ti

Birks Colibri forceps with 0.12mm teeth, 4mm platform, overall length 107mm

Cilia Forceps

0101264 **SS**

Whitfield cilia forceps, straight with angled tip.
3mm platform, overall length 91mm



0101265 **SS**

Bennett cilia forceps, straight with 3mm cup tips,
overall length 75mm



0101266 **SS**

Cilia forceps, straight with rounded tips.
4mm platform, overall length 78mm



0101268 **SS**

Cross action cilia forceps, angled with rounded
tips. 11mm tip to angle, overall length 105mm



0101267 **SS**

Barraquer cilia forceps, angled with rounded tips.
7mm platform, 7mm tip to angle, overall length
85mm



0101269 **SS**

Barraquer cilia forceps, angled with with rounded
tips. 8mm platform, 8mm tip to angle, overall
length 100mm



Muscle/Strabismus Forceps



0101592 SS

Troutman superior rectus forceps, angled with 0.5mm teeth. 10mm tip to angle, overall length 105mm



0101291 SS

Dastoor rectus forceps, 'S' shaped with 1 into 2 teeth. 10mm tip to angle, overall length 110mm



0101396 SS

Jameson strabismus forceps, locking, adult, angled **right** with 6 x 0.6mm teeth. 13mm tip to angle, overall length 99mm

0101394 SS

Jameson strabismus forceps, locking, adult, angled **left** with 6 x 0.6mm teeth. 13mm tip to angle, overall length 99mm



0101397 SS

Jameson strabismus forceps, locking, child, angled **right** with 4 x 0.6mm teeth. 8mm tip to angle, overall length 99mm

0101395 SS

Jameson strabismus forceps, locking, child, angled **left** with 4 x 0.6mm teeth. 18mm tip to angle, overall length 99mm



0101398 SS

Worth strabismus forceps, locking, angled **right** with 15mm longitudinal serrations. 13mm tip to angle, overall length 100mm

0101399 SS

Worth strabismus forceps, locking, angled **left** with 15mm longitudinal serrations. 13mm tip to angle, overall length 100mm



0109531 Ti

Federio müllerectomy forceps, 'T' ended with 25mm bar, 12 x 0.8mm interlocking teeth, overall length 105mm

Lens Forceps

0101593 **SS**

IOL folding forceps, angled with grooved paddles. 10mm tip to angle, overall length 108mm

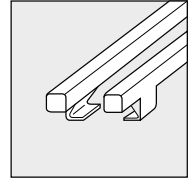

0109440 **Ti**

IOL folding forceps, angled with grooved paddles and central marker. 8mm tip to angle, overall length 108mm



0109163 **Ti**

IOL holding forceps, cross action, notch tip, angled with a catch. 25mm tip to angle, overall length 118mm

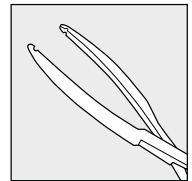

0109164 **Ti**

IOL holding forceps, cross action, notch tip, angled, no catch. 25mm tip to angle, overall length 118mm



0109448 **Ti**

IOL loading forceps, angled with atraumatic rounded tips and jaws, 15mm tip to angle, overall length 105mm

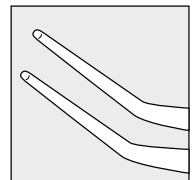

0109449 **Ti**

IOL loading forceps, straight with atraumatic rounded tips and jaws, 15mm jaws, overall length 110mm

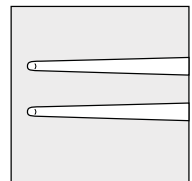

Artery Forceps



0101472 SS

Halstead mosquito forceps, straight with 20mm serrated tips, overall length 125mm



0101473 SS

Halstead mosquito forceps, curved with 26mm serrated tips, overall length 125mm



0101474 SS

Wells artery forceps, straight with 20mm serrated tips, overall length 95mm



0101475 SS

Wells artery forceps, curved with 20mm serrated tips, overall length 95mm

Forceps – towel clamps

0101589 **SS**

Towel clamp, cross action, straight, overall length 85mm



0101583 **SS**

Towel clamp, non-penetrating, curved, 5mm ball & socket tip, overall length 90mm



0204136 **SS**

Ramsey's sponge forceps, straight, 26mm serrated tips, overall length 182mm



0204147 **SS**

Backhaus towel clamp, curved, overall length 89mm



Forceps – specialist

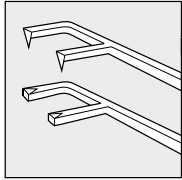

0109070 **Ti**

Polack Colibri forceps, 2 pronged for corneal suturing with 0.12mm teeth, 4.5mm platform, overall length 75mm



0101605 **SS**

Scleral plug forceps, cross action, angled tips have a 2mm groove for gripping scleral plug. 8mm tip to angle, overall length 106mm



0101552 **SS**

Watski sleeve forceps, reverse cross action for applying sleeve to retinal bands. Curved tips, overall length 116mm



0109181 **Ti**

Felipe fixation forceps, reverse cross action for fixating the eye during phaco. Angled, 12mm tip to angle, overall length 106mm



0101462 **SS**

Serrafine cross action mini clamp, straight. 10mm serrated jaws, overall length 38mm



0101463 **SS**

Serrafine cross action, feather weight, mini clamp, straight. 8mm serrated jaws, overall length 32mm



0101464 **SS**

Serrafine cross action, mini clamp, curved. 16mm serrated jaws, overall length 48mm

Specialist

0109185 **Ti**

Khaw conjunctival 'T' ended clamp with smooth, 12mm bar, overall length 86mm



0109186 **Ti**

Khaw-Shah conjunctival 'T' ended clamp with serrated 4mm bar, overall length 86mm



0204132 **SS**

Adson forceps, straight with 10mm serrated tips, overall length 122mm



0204134 **SS**

Adson forceps, straight with 0.5mm teeth, overall length 122mm



Needle Holders

Curved and straight, with or without catch



Needle holders are used when suturing – allowing the surgeon to both apply the needle at the correct angle to the tissue and achieve the correct depth. Stainless steel needle holders coming into contact with a magnetised surface will become magnetic, making it difficult to release a suture needle, for this reason titanium needle holders are often preferred.

Needle Holder anatomy

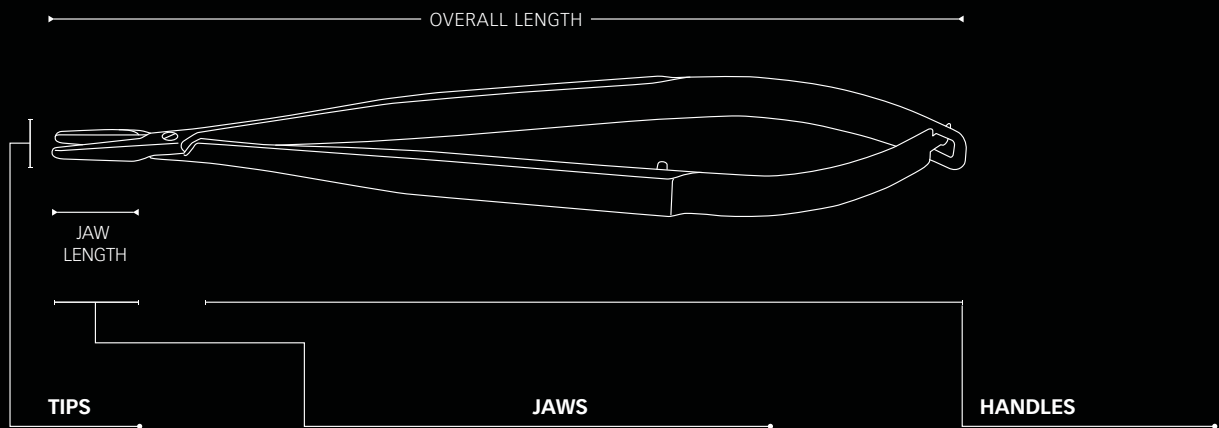

Fine/micro –
for finest sutures
e.g. corneal graft, cataract



Standard –
general purpose –
cataract, trabeculectomy

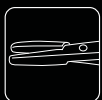

Heavy –
for larger sutures
e.g. strabismus, lid

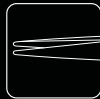

Straight



Curved

Choice depends on users
preference although curved
may give better visualisation
of the wound



Flat – for good manual grip
and control of the tip but may
require significant hand, wrist
or forearm movement



Round – rotating handle by
rolling between fingers allows
for 'micro' control of the tip
with minimum movement



Catch option – this is used
to lock the jaws in the closed
position – securing the needle
during suturing

Needle Holders

Curved with catch



0102007 SS

Castroviejo needle holder with a catch. Standard, curved, 10mm jaw, overall length 145mm



0102008 SS

Castroviejo needle holder with a catch. Curved, 12mm jaw, overall length 145mm



0102012 SS

Castroviejo needle holder, wide handle with a catch. Micro, curved, 10mm jaw, overall length 145mm



0102033 SS

Barraquer needle holder, round body with a catch. Fine, curved 8mm jaw, overall length 140mm



0109173 Ti

Weiss needle holder, round body with a catch. Fine, curved, 10mm jaw, overall length 124mm



0102063 SS

Troutman needle holder, round body with a catch. Tapered, curved, 8mm jaw, overall length 118mm



0102069 SS

Barraquer needle holder, round body with a catch. Grooved, curved, 5mm jaw, overall length 135mm

Needle Holders

Curved without catch

0102009 **SS**

Castroviejo needle holder, no catch. Standard, curved, 10mm jaw, overall length 145mm



0102010 **SS**

Castroviejo needle holder, no catch. Heavy, curved, 12mm jaw, overall length 145mm



0102011 **SS**

Castroviejo needle holder, wide handle, no catch. Micro, curved, 10mm jaw, overall length 145mm



0102032 **SS**

Barraquer needle holder, round body, no catch. Fine, curved, 8mm jaw, overall length 140mm



0109174 **Ti**

Weiss needle holder, round body, no catch. Fine, curved, 10mm jaw, overall length 124mm



0102062 **SS**

Troutman needle holder, round body, no catch. Tapered, curved, 8mm jaw, overall length 118mm



0109209 **Ti**

Troutman needle holder, round body, no catch. Micro, tapered, curved, 8mm jaw, overall length 118mm



Needle Holders



0109182 Ti

Troutman Ridgeway needle holder, round body, no catch. Fine, curved, 10mm jaw, overall length 125mm



0102064 SS

Troutman Tritt needle holder, round body, no catch. Micro, tapered, curved, 10mm jaw, overall length 122mm



0102065 SS

Troutman Tritt needle holder, round body, no catch. Heavy, tapered, curved, 10mm jaw, overall length 122mm



0109205 Ti

Micro needle holder, round body, no catch. Micro, tapered, curved, 8mm jaw, overall length 108mm



0102205S SS

Lim's needle holder, round body, no catch. Micro, curved, 5mm jaw, overall length 120mm



0109202 Ti

Lim's needle holder, round body, no catch. Micro, curved 5mm jaw, overall length 120mm

Needle Holders

Straight with catch

0102002 **SS**

Castroviejo needle holder with a catch. Standard, straight, 10mm jaw, overall length 145mm



0102005 **SS**

Castroviejo needle holder with a catch. Heavy, straight, 12mm jaw, overall length 145mm



0102014 **SS**

Castroviejo needle holder, wide handle with a catch. Micro, straight, 10mm jaw, overall length 145mm



0109193 **Ti**

Weiss needle holder, round body with a catch. Fine, straight, 10mm jaw, overall length 124mm



0102202 **SS**

Silcock needle holder with a catch. Heavy, straight, 8mm jaw, overall length 150mm



0102203 **SS**

Kalt needle holder with a catch. Heavy, straight, 8mm jaw, overall length 138mm



Needle Holders

Straight without catch



0102003 **SS**

Castroviejo needle holder, no catch. Standard, straight, 10mm jaw, overall length 145mm



0102006 **SS**

Castroviejo needle holder, no catch. Heavy, straight, 12mm jaw, overall length 145mm



0102013 **SS**

Castroviejo needle holder, wide handle, no catch. Micro, straight, 10mm jaw, overall length 145mm



0109210 **Ti**

Carlson-Troutman needle holder, short round body, no catch. Fine, straight, 8mm jaw, overall length 80mm



0109194 **Ti**

Weiss needle holder, round body, no catch. Fine, straight, 10mm jaw, overall length 124mm



0109203 **Ti**

Lim's needle holder, round body, no catch. Micro, straight, 5mm jaw, overall length 120mm

Scissors

Spring, bow/ ribbon. De Wecker, Vannas, Westcott, Williamson-Noble, Corneal, Capsulotomy, Strabismus, Stevens tenotomy, specialist, utility

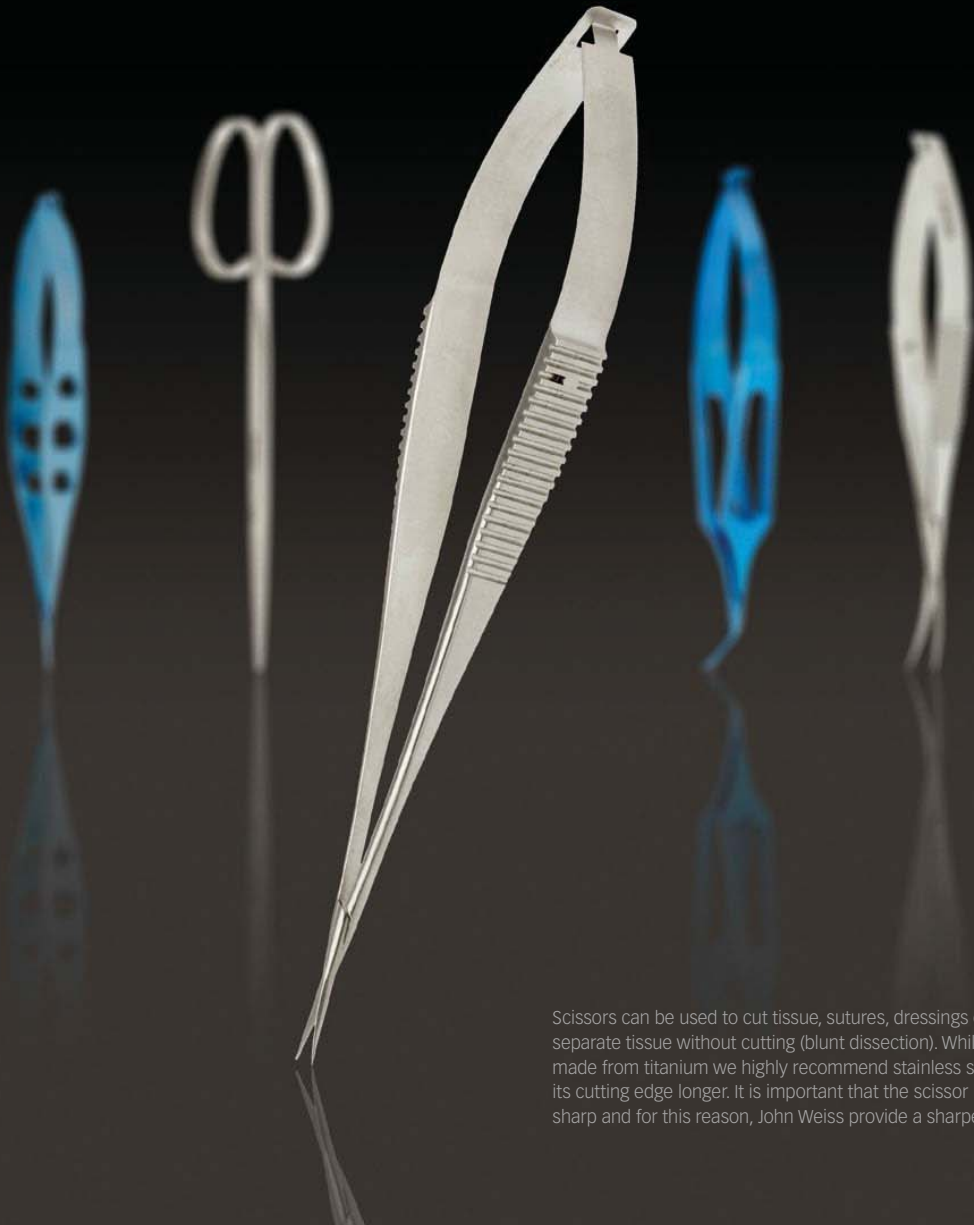

Scissors can be used to cut tissue, sutures, dressings or to divide or separate tissue without cutting (blunt dissection). While scissors can be made from titanium we highly recommend stainless steel as it maintains its cutting edge longer. It is important that the scissor blades are kept sharp and for this reason, John Weiss provide a sharpening service.

Scissors anatomy

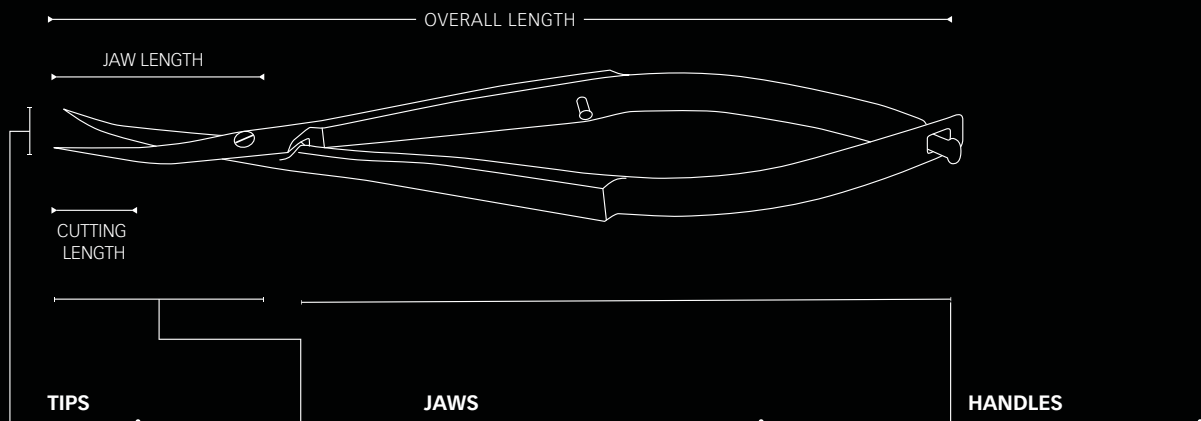

Sharp/pointed – can pierce tissue as well as cut



Rounded – for cutting only



Straight – good for when direct access is available or when a straight cut is required



Curved – to reach more difficult areas or when a curved cut is required. May allow better visualisation of tips



Angled – enables blades to be positioned at the correct angle to the tissue, particularly useful when excising



Spring – a good manual grip with excellent control of the tip means that these are the best choice for delicate work.

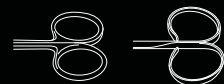

Bow or ribbon – traditional design, good utility scissor or for non-delicate excisions such as extraocular. May require significant hand and wrist movement.



Hinge – a time tested design, blades close by squeezing handle together. Generally used for iris excision.

Spring Scissors

De Wecker



0103245 SS

De Wecker Iris Scissors. Angled on flat with sharp tips. Max cutting length 5mm, blade length 8mm, overall length 110mm



0103242 SS

De Wecker iris scissors. Angled on flat with sharp tips. Max cutting length 9mm, blade length 12mm, overall length 115mm



0103243 SS

De Wecker Iris Scissors. Angled on flat with right tip sharp and left tip rounded. Max cutting length 9mm, blade length 12mm, overall length 115mm

0103244 SS

De Wecker Iris Scissors. Angled on flat with left tip sharp and right tip rounded. Max cutting length 9mm, blade length 12mm, overall length 115mm



0103252 SS

Barraquer Iris Scissors. Angled on flat with sharp tips. Max cutting length 6mm, blade length 8.5mm, overall length 58mm

Spring Scissors

Vannas – straight

0103102 **SS**

Vannas Scissors, straight with sharp tips.
Max cutting length 4mm, blade length 9mm,
overall length 86mm



0103105 **SS**

Vannas Scissors, straight with sharp tips.
Max cutting length 6mm, blade length 12mm,
overall length 89mm



0109003 **Ti**

Vannas Scissors, straight with sharp tips.
Max cutting length 3mm, blade length 9mm,
overall length 95mm



0109460 **Ti**

Vannas Scissors, straight with ultrafine, sharp
tips. Max cutting length 3mm, blade length 8mm,
overall length 110mm



0103123 **SS**

Miniature Scissors, straight with sharp tips.
Max cutting length 3mm, blade length 6.5mm,
overall length 85mm



0103129 **SS**

Miniature Scissors, straight sharp tips, long
handled. Max cutting length 3mm, blade
length 9mm, overall length 110mm



0103143 **SS**

Miniature Scissors, straight sharp tips, long
handled. Max cutting length 5mm, blade length
12mm, overall length 115mm



Spring Scissors

Vannas – curved



0103103 SS

Vannas Scissors, curved with sharp tips.
Max cutting length 4mm, blade length 9mm,
overall length 87mm



0103106 SS

Vannas Scissors, curved with sharp tips.
Max cutting length 5mm, blade length 12mm,
overall length 89mm



0109005 Ti

Vannas Scissors, curved with sharp tips.
Max cutting length 4mm, blade length 9mm,
overall length 94mm



0109461 Ti

Vannas Scissors, curved with ultrafine sharp
tips. Max cutting length 3mm, blade length 6mm,
overall length 106mm



0109462 Ti

Vannas Scissors, curved with ultrafine sharp tips
angled forward. Max cutting length 3mm, blade
length 6mm, overall length 106mm



0103128 SS

Miniature Scissors, curved with sharp tips.
Max cutting length 3mm, blade length 6.5mm,
overall length 82mm



0103122 SS

Miniature Scissors, angled with sharp tips,
angled on flat. Max cutting length 3mm, blade
length 9mm, overall length 82mm



0103124 SS

Miniature Scissors, angled with sharp tips side
cutting. Max cutting length 3mm blade length
9mm, overall length 82mm

Spring Scissors

Westcott

0103172 **SS**

Westcott Scissors, curved with rounded tips.
Max cutting length 9mm, blade length 23mm,
overall length 115mm



0103130 **SS**

McPherson-Westcott Scissors, curved with
sharp tips. Max cutting length 6mm, blade
length 12mm, overall length 100mm



0103173 **SS**

Westcott Scissors, curved with sharp tips.
Max cutting length 9mm, blade length 23mm,
overall length 115mm



0103182 **SS**

Westcott Scissors, curved with rounded tips.
Wide handle with a max cutting length 12mm,
blade length 23mm, overall length 139mm



0103183 **SS**

Westcott Scissors, curved with sharp tips. Wide
handle with a max cutting length 12mm, blade
length 23mm, overall length 139mm



Spring Scissors

Williamson-Noble



0103160 SS

Williamson-Noble Strabismus Scissors. Straight with rounded tips. Max cutting length 10mm, blade length 27mm, overall length 125mm



0103161 SS

Williamson-Noble Strabismus Scissors. Curved with rounded tips. Max cutting length 10mm, blade length 27mm, overall length 125mm



0103230 SS

Williamson-Noble Iris Scissors. Straight with sharp tips. Max cutting length 14mm, blade length 27mm, overall length 115mm



0103231 SS

Williamson-Noble Iris Scissors. Curved with sharp tips. Max cutting length 14mm, blade length 27mm, overall length 115mm

Spring Scissors

Corneal

0103033 **SS**

Castroviejo Corneal Scissors curved with fine rounded tips. Max cutting length 6mm, blade length 12mm, overall length 107mm



0103032 **SS**

Castroviejo Corneal Scissors curved with rounded tips. Max cutting length 9mm, blade length 21mm, overall length 120mm



0103040 **SS**

Castroviejo Corneal Scissors. Miniature, curved, wide handle with sharp tips. Max cutting length 5mm, blade length 14mm, overall length 129mm



Right or left cutting

0103019 **SS**

Katzin Corneal Scissors. Angled right cutting with fine rounded tips. Max cutting length 5mm, blade length 10mm, overall length 103mm



0103020 **SS**

Katzin Corneal Scissors. Angled left cutting with fine rounded tips. Max cutting length 5mm, blade length 10mm, overall length 103mm



0103046 **SS**

Troutman-Katzin Corneal Scissors Angled right cutting with rounded tips. Max cutting length 4mm, blade length 9mm, overall length 100mm



0103047 **SS**

Troutman-Katzin Corneal Scissors Angled left cutting with rounded tips. Max cutting length 4mm, blade length 9mm, overall length 100mm



Spring Scissors



0103012 **SS**

Castroviejo Corneal Scissors Angled right cutting with rounded tips. Max cutting length 8mm, blade length 15mm, overall length 107mm



0103015 **SS**

Castroviejo Corneal Scissors Angled left cutting with rounded tips. Max cutting length 8mm, blade length 15mm, overall length 107mm

Capsulotomy



0103082 **SS**

Capsulotomy scissors. Curved with sharp tips. Max cutting length 6mm, blade length 10.5mm, overall length 105mm



0103083 **SS**

Capsulotomy scissors round body. Curved with sharp tips. Max cutting length 6mm, blade length 12mm, overall length 122mm



0103085 **SS**

Ong scissors. Angled on flat with sharp tips. Max cutting length 7mm, blade length 14mm, overall length 90mm



0109002 **Ti**

Ong scissors. Angled on flat with sharp tips. Max cutting length 8mm, blade length 10mm, overall length 95mm



0103088 **SS**

Gills-Welsh scissors, Angled on flat with sharp tips Max cutting length 6mm, blade length 13mm, overall length 84mm

Bow / Ribbon Style Scissors

Strabismus

0103152 **SS**

Strabismus Scissors, straight with rounded tips. Max cutting length 25mm, blade length 32mm, overall length 115mm



0103162 **SS**

Strabismus Scissors, short shank, straight with rounded tips. Max cutting length 19mm, blade length 28mm, overall length 89mm



0103156 **SS**

Strabismus Scissors, ribbon style, straight with rounded tips. Max cutting length 24mm, blade length 31mm, overall length 110mm



0103159 **SS**

Strabismus Scissors, ribbon style, curved with ultrafine rounded tips. Max cutting length 17mm, blade length 19mm, overall length 98mm



0103154 **SS**

Strabismus Scissors, curved with rounded tips. Max cutting length 20mm, blade length 26mm, overall length 90mm



Bow / Ribbon Style Scissors

Stevens Tenotomy



0103174 **SS**

Stevens Tenotomy Scissors, straight with rounded tips. Max cutting length 16mm, blade length 22mm, overall length 104mm



0103175 **SS**

Stevens Tenotomy Scissors, curved with rounded tips. Max cutting length 19mm, blade length 22mm, overall length 105mm



0103179 **SS**

Stevens Tenotomy Scissors, curved with rounded tips. Max cutting length 24mm, blade length 31mm, overall length 112mm



0103178 **SS**

Stevens Tenotomy Scissors, straight with rounded tips. Max cutting length 26mm, blade length 31mm, overall length 115mm

Bow / Ribbon Style Scissors

Special

0103002 **SS**

Pooley Conjunctival Scissors, straight, rounded tips. Max cutting length 18mm, blade length 26mm, overall length 90mm



0103003 **SS**

Pooley Conjunctival Scissors, straight, rounded tips. Max cutting length 22mm, blade length 30mm, overall length 113mm



0103222 **SS**

Landolt Iris Scissors, curved with rounded tips. Max cutting length 19mm, blade length 28mm, overall length 112mm



0103268 **SS**

Werbs DCR Scissors, 5mm angled shaft with rounded tips. Max cutting length 23mm, blade length 30mm, overall length 115mm



Utility

0103227 **SS**

Scissors, straight with sharp tips. Max cutting length 23mm, blade length 30mm, overall length 115mm



0103224 **SS**

Scissors, curved with sharp tips. Max cutting length 23mm, blade length 30mm, overall length 115mm



Bow / Ribbon Style Scissors



0103228 SS

Scissors, straight, short shank with sharp tips.
Max cutting length 18mm, blade length 27mm,
overall length 90mm



0103229 SS

Scissors, curved, short shank with sharp tips.
Max cutting length 18mm, blade length 27mm,
overall length 90mm



0103205 SS

Scissors, straight with sharp tips.
Max cutting length 20mm, blade length 29mm,
overall length 110mm



0103206 SS

Scissors, curved with sharp tips.
Max cutting length 20mm, blade length 29mm,
overall length 110mm



0103202 SS

Scissors, curved with rounded tips. Max
cutting length 24mm, blade length 31mm,
overall length 115mm



0103204 SS

Scissors, straight extra long with rounded tips.
Max cutting length 24mm, blade length 31mm,
overall length 127mm



0103203 SS

Scissors, curved, extra long & strong with rounded
tips. Max cutting length 24mm, blade length
31mm, overall length 127mm

Bow / Ribbon Style Scissors

Utility

0103270 **SS**

Weiss Utility Scissors, straight with sharp tips.
Max cutting length 16mm, blade length 18mm,
overall length 95mm



0103269 **SS**

Weiss Utility Scissors, curved with sharp tips.
Max cutting length 16mm, blade length 18mm,
overall length 95mm



0103271 **SS**

Scissors, Straight, large ring with sharp tips.
Max cutting length 19mm, blade length 28mm,
overall length 100mm



0103272 **SS**

Scissors, Curved, large ring with sharp tips.
Max cutting length 19mm, blade length 28mm,
overall length 98mm



0103275 **SS**

Scissors, Ribbon style, straight with rounded tips.
Max cutting length 18mm, blade length 26mm,
overall length 103mm



0103276 **SS**

Scissors, Ribbon style, curved with rounded tips.
Max cutting length 18mm, blade length 26mm,
overall length 102mm



Choppers & Manipulators

Choppers & Splitters, Manipulators, Spatula / Repositors, Double ended combinations, Hooks, Vectis



This group covers a wide variety of instruments commonly called 'side port' or 'second' instrument. They are mainly used through the paracentesis incision but can also be used through the principle incision. Choppers and splitters are generally used to break up the crystalline lens while manipulators are used to move lens fragments or the intraocular lens (IOL). Other instruments that are of a similar design are hooks, used to atraumatically manipulate the lens or capsular bag; and vectis.

Chopper and Manipulator anatomy

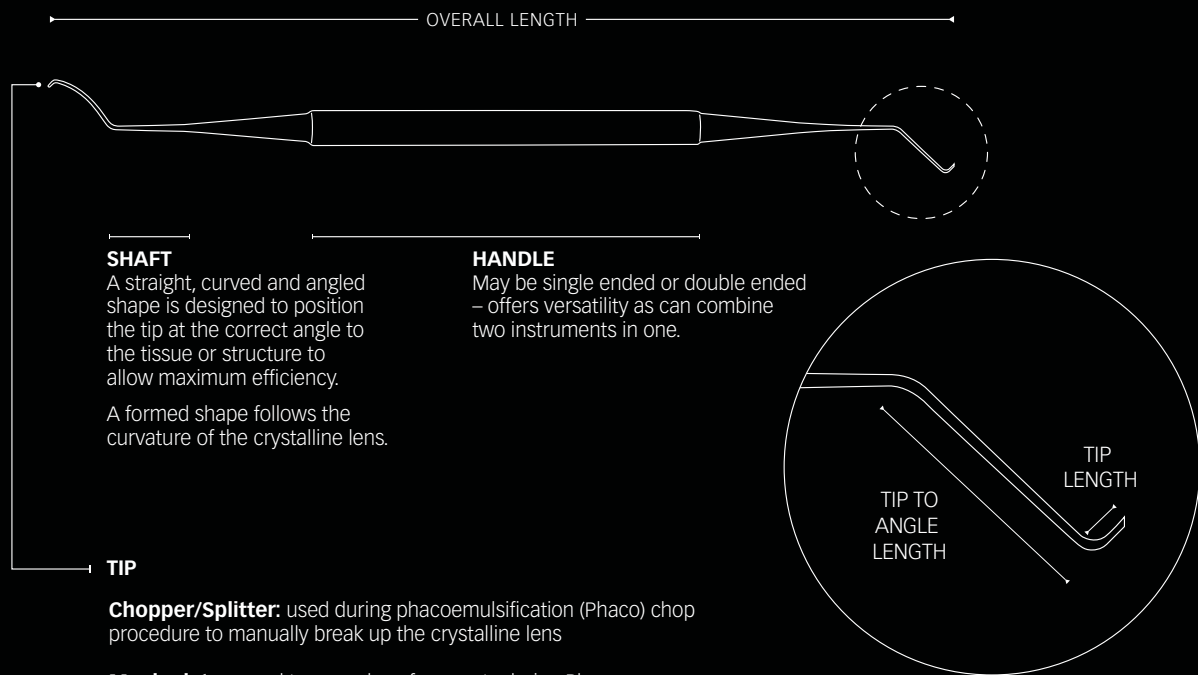

Chopper/Splitter: used during phacoemulsification (Phaco) chop procedure to manually break up the crystalline lens

Manipulator: used to move lens fragments during Phaco

Dialer: used to position the Intraocular lens implant (IOL)

Hook (micro): designed to 'push' or 'pull' the iris or lens capsule

Vectis: a traditional instrument designed to support the crystalline lens and aid with its removal during intracapsular cataract extraction procedure

Repositor: used to reposition tissue, usually iris. May also be used to separate adhesions (synechia) between the iris and lens capsule.

Choppers & Splitters

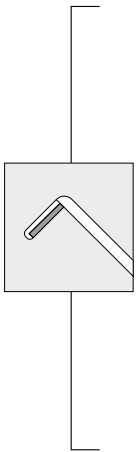

0109301 Ti

Phaco chopper, angled with 1mm blade, 10mm tip to angle, overall length 112mm



0109302 Ti

Phaco chopper, angled with a 1mm 30° left, offset blade. 10mm tip to angle, overall length 112mm



0109304 Ti

Koch phaco chopper, angled with a 1mm blade. 10mm tip to angle, overall length 110mm



0109310 Ti

Phaco chopper, angled with an extra long 1.5mm blade. 10mm tip to angle, overall length 115mm

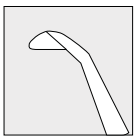

0109314 Ti

Green's phaco chopper, angled. 10mm tip to angle, overall length 115mm

0109314L Ti

Green's phaco chopper, angled, for right handed use. 10mm tip to angle, overall length 115mm

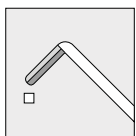

0109305 Ti

Stevens phaco chopper, angled with a dual forward and rear cutting blade. 10mm tip to angle, overall length 120mm

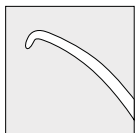

0109318 Ti

Spalton phaco chopper, angled. 8mm tip to angle, overall length 112mm

Choppers & Splitters

0109300 **Ti**

Small pupil phaco chopper, angled.
10mm tip to angle, overall length 112mm

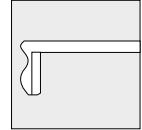

0109225 **Ti**

Nucleus splitter, angled. 10mm tip to angle,
overall length 112mm

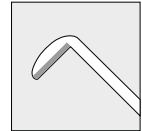

0109227 **Ti**

Tamblyn nucleus splitter/ manipulator, angled.
10mm tip to angle, overall length 118mm

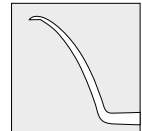

0105138 **SS**

Phaco cleaver, angled. 10mm tip to angle,
overall length 125mm

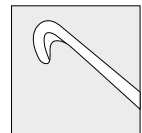

0105140 **SS**

Akahoshi hybrid pre-chopper, straight,
overall length 123mm



0105141 **SS**

Akahoshi combo pre-chopper, straight,
overall length 123mm



Manipulators

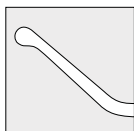

0109222 Ti

Drysdale nucleus manipulator, angled with a paddle tip. 11mm tip to angle, overall length 112mm

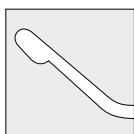

0109220 Ti

Rosen nucleus manipulator, angled with a paddle tip. 10mm tip to angle, overall length 120mm

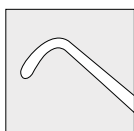

0109226 Ti

Microfinger angled, for **right** handed use. 10mm tip to angle, overall length 118mm

0109226L Ti

Microfinger angled, for **left** handed use. 10mm tip to angle, overall length 118mm

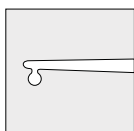

0109218 Ti

Lester lens pusher, straight, overall length 118mm



0109219 Ti

Lester lens pusher, angled. 10mm tip to angle, overall length 118mm

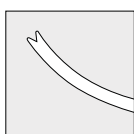

0109306 Ti

Joyce manipulator, curved with a horizontal groove in tip, overall length 120mm

Manipulators

0105132 **SS**

Kuglen lens manipulator, straight,
overall length 122mm



0105133 **SS**

Kuglen lens manipulator, angled. 10mm tip to angle,
overall length 120mm



0109229 **Ti**

Kuglen lens manipulator, straight,
overall length 115mm



0109230 **Ti**

Kuglen lens manipulator, angled. 10mm tip to angle,
overall length 115mm



0105135 **SS**

Graether collar button manipulator, angled.
10mm tip to angle, overall length 120mm



0109231 **Ti**

Jaffe-Bechert nucleus rotator, angled with a
horizontal 'Y' tip. 10mm tip to angle, overall length
115mm



0105155 **SS**

Jaffe-Bechert nucleus rotator, angled with a vertical
'Y' tip. 8mm tip to angle, overall length 110mm

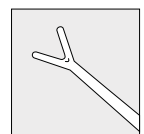
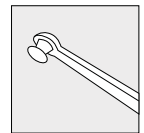
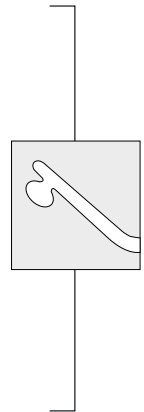

Manipulators

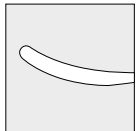

0105136 **SS**

Koch manipulator, curved with smooth, flat tip, overall length 115mm

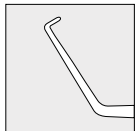

0109224 **Ti**

Koch manipulator, curved with smooth, flat tip, overall length 115mm

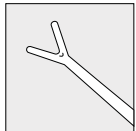

0109319 **Ti**

Spalton reverse dialler, angled. 10mm tip to angle, overall length 115mm

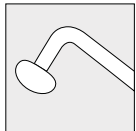

0105153 **SS**

Osher manipulator, angled with 'Y' tip. 10mm tip to angle, overall length 115mm



0109316 **Ti**

Mushroom manipulator, angled. 10mm tip to angle, overall length 115mm

Spatula / Repositors

0106051 **SS**

Gimble spatula angled with 0.25mm diameter smooth, flat tip. 10mm tip to angle, overall length 128mm

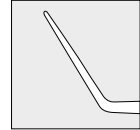

0106004 **SS**

Nettleship iris repositor, straight, overall length 130mm

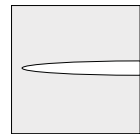

0109212 **Ti**

Iris repositor, angled. 14mm tip to angle, overall length 116mm

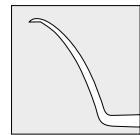

0106023 **SS**

Troutman cyclodialysis spatula, angled. 15mm tip to angle, overall length 95mm



Double ended combinations

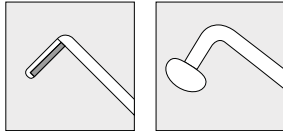

0109527 Ti

Raj phaco chopper and mushroom manipulator, angled. 10mm tip to angle, overall length 125mm

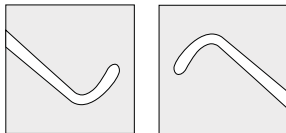

0109228 Ti

Microfinger for left hand plus microfinger for right hand, angled. 10mm tip to angle, overall length 145mm

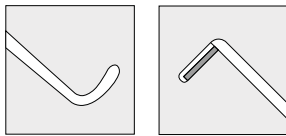

0109309 Ti

Microfinger and phaco chopper, angled. 10mm tip to angle, overall length 135mm

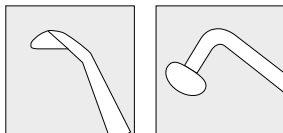

0109312 Ti

Green's phaco chopper and mushroom manipulator, angled. 10mm tip to angle, overall length 132mm

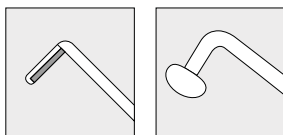

0109317 Ti

Phaco chopper and mushroom manipulator, angled. 10mm tip to angle, overall length 135mm

Note: bespoke double ended variations may be available to order

Double ended combinations

0109315 **Ti**

Jaffe-Bechert 'Y' rotator and mushroom manipulator, angled. 8mm tip to angle, overall length 135mm

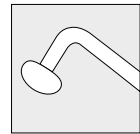
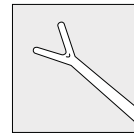

0109308 **Ti**

Triple chopper with 3 cutting edges and mushroom manipulator, angled. 10mm tip to angle, overall length 135mm

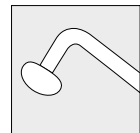
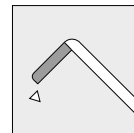

0109307 **Ti**

Nucleus rotator with 'Y' tip and flat rotator, angled. 10mm tip to angle, overall length 140mm

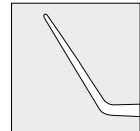
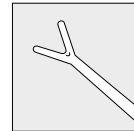

0106042 **SS**

Castroviejo cyclodialysis/synechia spatula, angled. 10mm x 0.5mm blade and 0.5mm x 15mm blade, overall length 130mm

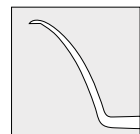
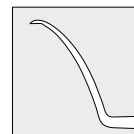

Note: bespoke double ended variations may be available to order

Hooks

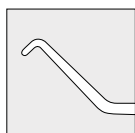

0109214 **Ti**

Sinskey dialing hook, angled. 10mm tip to angle, overall length 120mm



0105109 **SS**

Sinskey dialing hook, angled. 10mm tip to angle, overall length 115mm

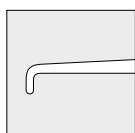

0109216 **Ti**

Sinskey dialing hook, straight, overall length 120mm



0105107 **SS**

Sinskey dialing hook, straight, overall length 115mm

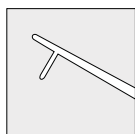

0109232 **Ti**

Fenzl hook, angled with 2mm hook. 10mm tip to angle, overall length 115mm

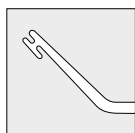

0109217 **Ti**

Hirshman iris hook, angled. 10mm tip to angle, overall length 120mm

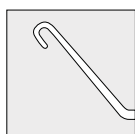

0109215 **Ti**

Iris hook, angled. 10mm tip to angle, overall length 117mm

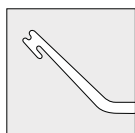

0109233 **Ti**

Makool capsule retractor and guide, angled. 13mm tip to angle, overall length 120mm

Hooks

0105072 **SS**

Graefe strabismus hook, straight with 5mm small hook, overall length 138mm



0105073 **SS**

Graefe strabismus hook, straight with 8mm medium hook, overall length 138mm



0105074 **SS**

Graefe strabismus hook, straight with 10mm large hook, overall length 138mm



0105075 **SS**

Moorfields strabismus hook, straight with 8mm hook, overall length 138mm



0105076 **SS**

Chauvasse strabismus hook, straight with 12mm hook, overall length 134mm



0105082 **SS**

Maidstone oculoplastic hook for lateral canthoplasty with fenestration at tip. 13mm hook, overall length 138mm



0105080 **SS**

Assaf muscle hook, adult, flat grooved 7mm hook, overall length 145mm



0105081 **SS**

Assaf muscle hook, child, flat grooved 5mm hook, overall length 145mm



Hooks



0114232 **SS**

Lens expressor, angled on flat, rounded tip.
10mm tip to angle, overall length 145mm



0105102 **SS**

Kilner hook, straight with a 3mm sharp pointed
hook, overall length 140mm



0202352 **SS**

Gilles skin hook small, straight with a 3mm sharp
pointed hook, overall length 185mm



0202354 **SS**

Gilles skin hook large, straight with a 4mm sharp
pointed hook, overall length 185mm

Vectis

0108062 **SS**

Snellen vectis, straight with 8.5mm x 2.5mm oval, overall length 140mm



0108063 **SS**

Bell Taylor vectis, straight with 7.0mm x 4.5mm oval, overall length 140mm



0108064 **SS**

Landolt vectis, straight with 5.5mm x 4mm oval, overall length 125mm



0108070 **SS**

Narrow vectis, straight with 7.5mm x 2.5mm oval, overall length 138mm



Specula

Adjustable or Non-adjustable Infant and Adult

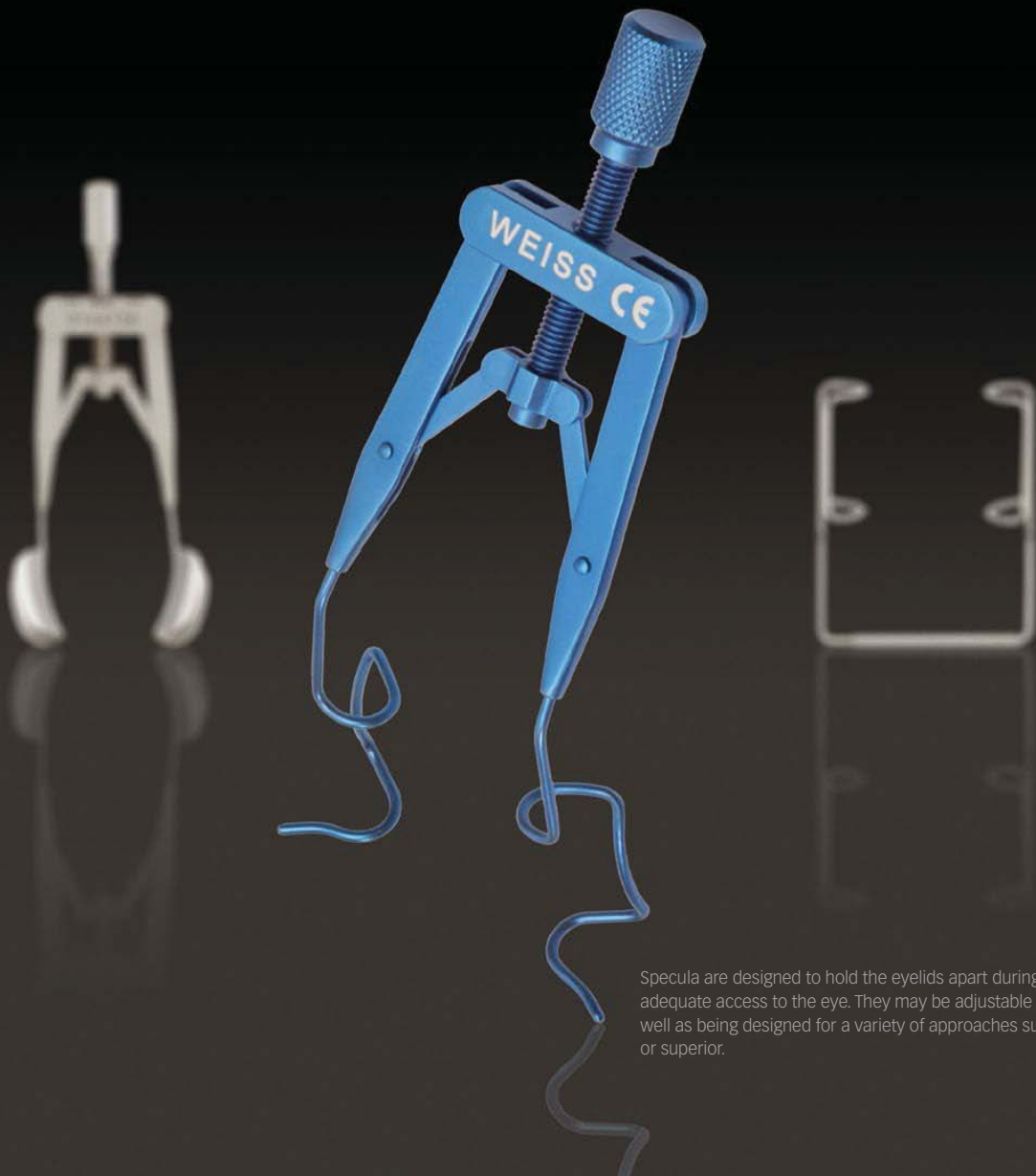

Specula are designed to hold the eyelids apart during surgery allowing adequate access to the eye. They may be adjustable or non-adjustable as well as being designed for a variety of approaches such as temporal or superior.

Specula anatomy

NON-ADJUSTABLE

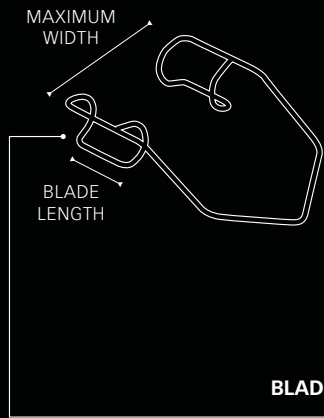

ADJUSTABLE

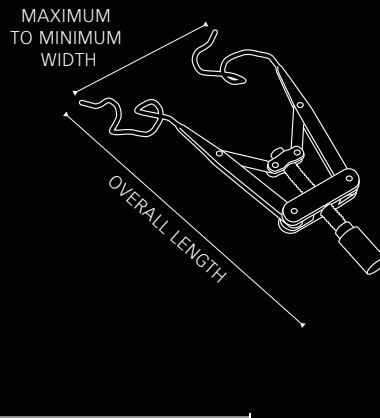

BLADE



Open: allows good access for instruments
e.g. Phaco handpiece that might otherwise rest on the top bar of a closed blade making surgery difficult

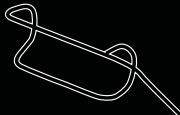

Closed: good hold on eyelids for procedures where the top bar does not cause a problem
e.g. trabeculectomy or temporal incision phaco



Wire: more comfortable for the patient under local anaesthetic, particularly when used with a sliding wire speculum or a non-adjustable speculum



Solid: holds eyelids securely

Specula

Non-adjustable – Infant



0104090 **SS**

Barraquer speculum for baby with 12mm closed wire blades. 14mm maximum opening, overall length 30mm



0104075 **SS**

Barraquer speculum for child with 12mm closed wire blades. 15mm maximum opening, overall length 42mm



0104130 **SS**

Barraquer speculum for child with 11mm solid blades. 18mm maximum opening, overall length 40mm

Note: Maximum opening for non-adjustable speculum is measured at rest and may be reduced under lid tension

Specula

Non-adjustable – Adult

0104074 **SS**

Barraquer speculum for adult with 17mm closed wire blades. 16mm maximum opening, overall length 45mm



0104131 **SS**

Barraquer speculum for adult with 15mm solid blades. 18mm maximum opening, overall length 38mm



0104078 **SS**

Kratz-Barraquer speculum for adult with 13mm open wire blades. 18mm maximum opening, overall length 45mm



0109401 **Ti**

Kratz-Barraquer speculum for adult with 8mm open wire blades. 18mm maximum opening, overall length 42mm

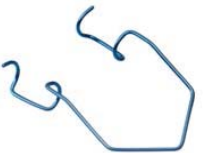

0104087 **SS**

Kratz-Barraquer temporal incision speculum for adult with 12mm open wire blades. 18mm maximum opening, overall length 45mm



0104135 **SS**

Sauer speculum with 10mm solid blades. 18mm maximum opening, overall length 16mm



Note: Maximum opening for non-adjustable speculum is measured at rest and may be reduced under lid tension

Specula

Adjustable – Infant



0104006

Clarke speculum for baby with 8mm open blades.30mm maximum opening, overall length 65mm



0104004

Clarke speculum for child with 12mm open blades.30mm maximum opening, overall length 70mm



0104132

SS

Jaffe lid retractor, small with 10mm open wire blade, overall length 40mm. Comes as a pair.

Specula

Adjustable – Adult

0104085 **SS**

Barraquer sliding speculum for adult with 17mm closed wire blades. 25mm maximum opening, overall length 35mm



0104083 **SS**

Kratz-Barraquer sliding speculum for adult with 12mm open wire blades. 25mm maximum opening, overall length 32mm



0104112 **SS**

Pierse sliding speculum for adult with 12mm open wire blades. 25mm maximum opening, overall length 35mm



0104002

Clarke speculum for adult with 14mm open blades. 30mm maximum opening, overall length 85mm



0109410 **Ti**

Lieberman speculum for adult with 15mm open 'K' wire blades. 45mm maximum opening, overall length 84mm



Specula

Adjustable – Adult



0104142 SS

Lieberman speculum for adult with 15mm open 'K' wire blades. 40mm maximum opening, overall length 82mm*



0104128 SS

Lieberman speculum for adult with 15mm open 'V' wire blades. 35mm maximum opening, overall length 82mm*



0104129S SS

Lieberman temporal incision speculum for adult with 15mm open 'K' wire blades. 35mm maximum opening, overall length 78mm*



0104137 SS

Lieberman speculum for adult with 9mm solid blades. 40mm maximum opening, overall length 82mm



0104136 SS

Lieberman speculum for adult with 15mm solid blades, suitable for both standard and temporal incision. 45mm maximum opening, overall length 75mm

*Aspirating versions are available on request

Specula

Adjustable – Adult

0104141 **SS**

Knapp speculum for adult with 15mm open wire blades. 33mm maximum opening, overall length 84mm



0104134 **SS**

Lancaster speculum for adult with 15mm solid blades. 38mm maximum opening, overall length 82mm



0104133 **SS**

Jaffe lid retractor, large with 15mm open wire blade, overall length 40mm. Comes as a pair.



Extraocular

Lid, Chalazion and Cyst, Ptosis, Entropion / Ectropion, Strabismus. Lacrimal probes & dilators, Lester Jones Tubes, DCR punches & intubation sets. Retractors & Hooks. Chisels & Osteotomes. Orbital instruments & implants. Enucleation / Evisceration.



Extraocular procedures are performed on the external structures of the eye and surrounding tissue (adnexa). These are usually dealt with by Oculoplastic, Strabismus or Orbital specialists and include surgery to the eyelids, extraocular muscles, lacrimal and orbital structures.

How to dismantle and reassemble the take apart Kerrison punch

Sphenoidal punches are designed for cutting the sphenoid bone during dacryocystorhinostomy (DCR) surgery. John Weiss manufacture a specific range of Kerrison punches, referred to as 'take-apart', that are specifically designed to be taken apart for ease of cleaning.



TO DISMANTLE

Squeeze handle together to close tip, pull hammer down and release the handle. The top bar can now be lifted to clean.
Note: the top bar cannot be fully removed from the instrument.

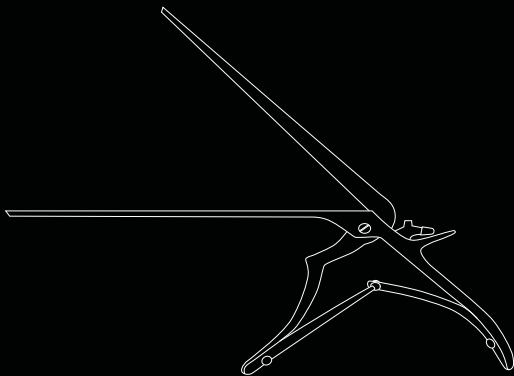

TO REASSEMBLE

Hold with tip pointing down. Ensure ejector is pushed fully downwards towards the cutting edge.

Lower the top bar ensuring slots are located correctly then squeeze the handle closed. Finally push the hammer up – locking everything in place.

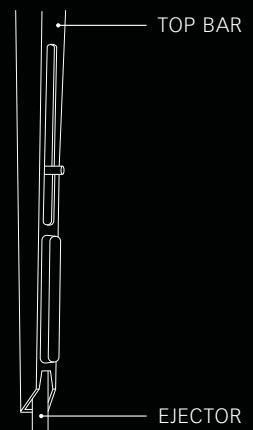

Lid instruments

Chalazion and Cyst



0101412 SS

Green tarsal cyst forceps with 10mm round, serrated plate, overall length 90mm



0101413 SS

Birmingham tarsal cyst forceps, with 20mm x 14mm smooth, oval plate, overall length 90mm



0101415 SS

Ayres tarsal cyst forceps with 7mm smooth, round plate, overall length 90mm



0101422 SS

Desmarres chalazion forceps with 16mm x 11mm smooth, oval plate, overall length 86mm



0101423 SS

Desmarres chalazion forceps with 20mm x 10mm smooth, oval plate, overall length 90mm



0101424 SS

Desmarres chalazion forceps with 26mm x 15mm smooth, oval plate, overall length 90mm



0101425 SS

Desmarres chalazion forceps with 31mm x 20mm smooth, oval plate, overall length 95mm

Lid instruments

Chalazion and Cyst

0101426 **SS**

Lambert chalazion forceps with 10mm smooth, round plate, overall length 92mm



0101427 **SS**

Lambert chalazion forceps with 15mm smooth, round plate, overall length 98mm



0101428 **SS**

Francis chalazion forceps with 16mm x 13mm smooth, oval plate, overall length 98mm



0114220 **SS**

Meibomian cyst curette, double ended with 2 x 9mm x 4mm cups, overall length 126mm



Lid instruments

Chalazion and Cyst



0114213 **SS**

Sharp spoon size A with 1.5mm round cup, overall length 122mm



0114214 **SS**

Sharp spoon size B with 2.0mm round cup, overall length 122mm



0114215 **SS**

Sharp spoon size C with 3.0mm x 2.2mm oval cup, overall length 124mm



0114216 **SS**

Sharp spoon size D with 3.8mm x 2.7mm oval cup, overall length 124mm



0114217 **SS**

Sharp spoon size E with 4.6mm x 3.0mm oval cup, overall length 124mm



0114218 **SS**

Sharp spoon size F with 5.7mm x 3.7mm oval cup, overall length 124mm

Lid instruments

Ptosis

0101442 **SS**

Berke ptosis forceps, locking with **15mm** serrated jaws, overall length 110mm



0101444 **SS**

Berke ptosis forceps, locking with **27mm** serrated jaws, overall length 110mm



0114266 **SS**

Collin lid crease reformer **right**, with 50mm curved blade, slightly angled down, overall length 115mm



0114265 **SS**

Collin lid crease reformer **left**, with 50mm curved blade, slightly angled down, overall length 115mm



0109531 **Ti**

Federio müllerectomy forceps, 'T' ended with 25mm bar, 12 x 0.8mm interlocking teeth, overall length 105mm



Lid instruments

Entropian / Ectropian



0101452 **SS**

Desmarres entropian forceps right,
with 28mm x 15mm smooth plate,
overall length 90mm



0101453 **SS**

Desmarres entropian forceps left,
with 28mm x 15mm smooth plate,
overall length 90mm



0106048 **SS**

MacCallan entropian lid plate, smooth,
double ended with 1x 20mm and 1x 22mm
plates, overall length 112mm



0106049

Jaeger entropian insulated lid plate, smooth,
double ended with 1 x 18mm and 1 x 20mm
plates, overall length 110mm

Lid instruments

Strabismus

0101396 SS

Jameson strabismus forceps, locking, adult, angled right with 6 x 0.6mm teeth. 13mm tip to angle, overall length 99mm



0101394 SS

Jameson strabismus forceps, locking, adult, angled left with 6 x 0.6mm teeth. 13mm tip to angle, overall length 99mm



0101397 SS

Jameson strabismus forceps, locking, child, angled right with 4 x 0.6mm teeth. 8mm tip to angle, overall length 99mm



0101395 SS

Jameson strabismus forceps, locking, child, angled left with 4 x 0.6mm teeth. 18mm tip to angle, overall length 99mm



0101398 SS

Worth strabismus forceps, locking, angled **right** with 15mm longitudinal serrations. 13mm tip to angle, overall length 100mm



0101399 SS

Worth strabismus forceps, locking, angled **left** with 15mm longitudinal serrations, overall length 100mm



0101592 SS

Troutman superior rectus forceps, angled with 0.5mm teeth. 10mm tip to angle, overall length 105mm



Lid instruments

Strabismus



0101291 SS

Dastoor rectus forceps, 'S' shaped with 1 into 2 teeth. 10mm tip to angle, overall length 110mm



0105072 SS

Graefe small strabismus hook, straight with 5mm hook, overall length 138mm



0105073 SS

Graefe medium strabismus hook, straight with 8mm hook, overall length 138mm



0105074 SS

Graefe large strabismus hook, straight with 10mm hook, overall length 138mm



0105075 SS

Moorfields strabismus hook, straight with 8mm hook, overall length 138mm



0105076 SS

Chauvasse strabismus hook, straight with 12mm hook, overall length 134mm

Lacrimal & DCR

Silver

0105008

Liebreichs (Bowmans) probes. **Available as a set of 4 or individually as below.**

0105011

Liebreichs (Bowmans) probes, 0000 & 000 double ended, overall length 126mm

0105012

Liebreichs (Bowmans) probes, 00 & 0 double ended, overall length 126mm

0105013

Liebreichs (Bowmans) probes, 1 & 2 double ended, overall length 126mm

0105016

Liebreichs (Bowmans) probes, 3 & 4 double ended, overall length 126mm

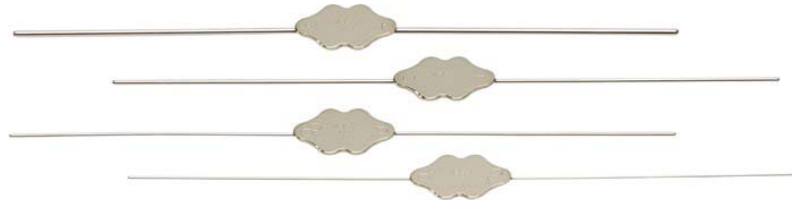

0105010 **SS**

Pigtail probe with fenestration at tip, double ended for right or left use, overall length 140mm



0105033 **SS**

Nettleship dilator straight with 27mm tapered tip, overall length 110mm



0105034 **SS**

Nettleship dilator double ended straight with 1x 23mm & 1x 27mm tapered tips, overall length 117mm



Lacrimal & DCR



0105036 **SS**

Wilder dilator, straight with 20mm fine tapered tip, overall length 112mm



0105037 **SS**

Wilder dilator, straight with 16mm medium tapered tip, overall length 112mm



0105038 **SS**

Lacrimal dilator for infant, straight with a 22mm delicate taper, overall length 82mm



0105040 **SS**

Castroviejo dilator, straight, double ended with 1x 18mm and 1x 22mm tapered tips, overall length 138mm



0105154 **SS**

Hays punctum finder 23mm straight, pointed, overall length 125mm



0105170 **SS**

Beigi dilating probe. Fine, double ended with 24mm dilator and 22mm probe, overall length 140mm



0103268 **SS**

Werbs DCR Scissors, 5mm angled shaft with rounded tips. Max cutting length 23mm, blade length 30mm, overall length 115mm

Lacrimal Implants

Lester Jones Tubes

| | Description | Flange diameter & tube length | | |
|---------|--|-------------------------------|----------|-------|
| 0110019 | Lester Jones Tube 2.2mm, bevelled | 3.0mm x 10mm | Straight | Pyrex |
| 0110029 | Lester Jones Tube 2.2mm, bevelled | 3.0mm x 11mm | Straight | Pyrex |
| 0110020 | Lester Jones Tube 2.2mm, bevelled | 3.0mm x 12mm | Straight | Pyrex |
| 0110030 | Lester Jones Tube 2.2mm, bevelled | 3.0mm x 13mm | Straight | Pyrex |
| 0110009 | Lester Jones Tube 2.2mm, bevelled | 3.0mm x 14mm | Straight | Pyrex |
| 0110031 | Lester Jones Tube 2.2mm, bevelled | 3.0mm x 15mm | Straight | Pyrex |
| 0110022 | Lester Jones Tube 2.2mm, bevelled | 3.0mm x 16mm | Straight | Pyrex |
| 0110003 | Lester Jones Tube 2.2mm, bevelled | 3.5mm x 10mm | straight | Pyrex |
| 0110014 | Lester Jones Tube 2.2mm, bevelled | 3.5mm x 11mm | straight | Pyrex |
| 0110004 | Lester Jones Tube 2.2mm, bevelled | 3.5mm x 12mm | straight | Pyrex |
| 0110005 | Lester Jones Tube 2.2mm, bevelled | 3.5mm x 13mm | straight | Pyrex |
| 0110006 | Lester Jones Tube 2.2mm, bevelled | 3.5mm x 14mm | straight | Pyrex |
| 0110007 | Lester Jones Tube 2.2mm, bevelled | 3.5mm x 15mm | straight | Pyrex |
| 0110008 | Lester Jones Tube 2.2mm, bevelled | 3.5mm x 16mm | straight | Pyrex |
| 0110018 | Lester Jones Tube 2.2mm, bevelled | 3.5mm x 17mm | straight | Pyrex |
| 0110026 | Lester Jones Tube 2.2mm, bevelled | 3.5mm x 18mm | straight | Pyrex |
| 0110027 | Lester Jones Tube 2.2mm, bevelled | 3.5mm x 19mm | straight | Pyrex |
| 0110032 | Lester Jones Tube 2.2mm, bevelled | 4.0mm x 12mm | straight | Pyrex |
| 0110033 | Lester Jones Tube 2.2mm, bevelled | 4.0mm x 13mm | straight | Pyrex |
| 0110034 | Lester Jones Tube 2.2mm, bevelled | 4.0mm x 14mm | straight | Pyrex |
| 0110010 | Lester Jones Tube 2.2mm, bevelled | 4.0mm x 15mm | straight | Pyrex |
| 0110011 | Lester Jones Tube 2.2mm, bevelled | 4.0mm x 16mm | straight | Pyrex |
| 0110039 | Lester Jones Tube 2.2mm, bevelled | 4.0mm x 17mm | straight | Pyrex |
| 0110012 | Lester Jones Tube 2.2mm, bevelled | 4.0mm x 18mm | straight | Pyrex |
| 0110040 | Lester Jones Tube 2.2mm, bevelled | 4.0mm x 19mm | straight | Pyrex |
| 0110041 | Lester Jones Tube 2.2mm, bevelled | 4.0mm x 20mm | straight | Pyrex |
| 0110054 | Lester Jones Tube 2.2mm, bevelled | 4.0mm x 21mm | straight | Pyrex |
| 0110043 | Lester Jones Tube 2.2mm, bevelled | 4.0mm x 22mm | straight | Pyrex |
| 0110042 | Lester Jones Tube 2.2mm, without bevel | 4.0mm x 21mm | straight | Pyrex |
| 0110044 | Lester Jones Tube 2.2mm, without bevel | 4.0mm x 24mm | straight | Pyrex |



Lacrimal Implants

Lester Jones Tubes



| | Description | Flange diameter & tube length | | |
|----------------|-----------------------------------|-------------------------------|--------|-------|
| 0110059 | Lester Jones Tube 2.2mm, bevelled | 3.0mm x 12mm | angled | Pyrex |
| 0110060 | Lester Jones Tube 2.2mm, bevelled | 3.0mm x 16mm | angled | Pyrex |
| 0110048 | Lester Jones Tube 2.2mm, bevelled | 3.0mm x 17mm | angled | Pyrex |
| 0110058 | Lester Jones Tube 2.2mm, bevelled | 3.5mm x 12mm | angled | Pyrex |
| 0110016 | Lester Jones Tube 2.2mm, bevelled | 3.5mm x 14mm | angled | Pyrex |
| 0110017 | Lester Jones Tube 2.2mm, bevelled | 3.5mm x 15mm | angled | Pyrex |
| 0110055 | Lester Jones Tube 2.2mm, bevelled | 3.5mm x 16mm | angled | Pyrex |
| 0110049 | Lester Jones Tube 2.2mm, bevelled | 3.5mm x 17mm | angled | Pyrex |
| 0110062 | Lester Jones Tube 2.2mm, bevelled | 3.5mm x 19mm | angled | Pyrex |
| 0110143 | Lester Jones Tube 2.2mm, bevelled | 3.5mm x 24mm | angled | Pyrex |
| 0110024 | Lester Jones Tube 2.2mm, bevelled | 4.0mm x 14mm | angled | Pyrex |
| 0110025 | Lester Jones Tube 2.2mm, bevelled | 4.0mm x 15mm | angled | Pyrex |
| 0110050 | Lester Jones Tube 2.2mm, bevelled | 4.0mm x 16mm | angled | Pyrex |
| 0110051 | Lester Jones Tube 2.2mm, bevelled | 4.0mm x 17mm | angled | Pyrex |
| 0110053 | Lester Jones Tube 2.2mm, bevelled | 4.0mm x 18mm | angled | Pyrex |
| 0110052 | Lester Jones Tube 2.2mm, bevelled | 4.0mm x 19mm | angled | Pyrex |

Lester Jones tubes are also available in a frosted version – specify when ordering.
Lester Jones tubes can be made to specification and with suture holes, specify flange diameter and length.
Sold individually as non-sterile units.



| | | | | |
|----------------|----------------------------|--------------|----------|------|
| 0110036 | Bevelled polyethylene tube | 4.5mm x 18mm | Straight | Poly |
|----------------|----------------------------|--------------|----------|------|

Lacrimal Implants

Lester Jones sets

0110002

Standard Set

| | |
|-----|--------------------------|
| 2 x | 3.0mm x 14mm |
| 2 x | 3.5mm x 12mm |
| 2 x | 3.5mm x 13mm |
| 2 x | 3.5mm x 14mm |
| 2 x | 3.5mm x 15mm |
| 2 x | 4.0mm x 15mm |
| 1 x | 4.0mm x 16mm |
| 1 x | 4.0mm x 18mm |
| 2 x | Poly tube (4.5mm flange) |
| 5 x | Nylon cleaning rods |
| 1 x | Gold dilator No.1 |
| 1 x | Gold dilator No.2 |

0110013

Assorted Set

| | |
|-----|--------------------------|
| 1 x | 3.0mm x 10mm |
| 1 x | 3.0mm x 12mm |
| 1 x | 3.0mm x 14mm |
| 1 x | 3.0mm x 16mm |
| 1 x | 3.5mm x 11mm |
| 1 x | 3.5mm x 13mm |
| 1 x | 3.5mm x 15mm |
| 1 x | 3.5mm x 17mm |
| 1 x | 4.0mm x 15mm |
| 1 x | 3.5mm x 14mm angled |
| 1 x | 3.5mm x 15mm angled |
| 1 x | 4.0mm x 14mm angled |
| 1 x | 4.0mm x 15mm angled |
| 2 x | Poly tube (4.5mm flange) |
| 5 x | Nylon cleaning rods |
| 1 x | Gold dilator No.1 |
| 1 x | Gold dilator No.2 |

0110038

Special Set

| | |
|-----|--------------------------|
| 1 x | 3.0mm x 10mm |
| 1 x | 3.0mm x 11mm |
| 1 x | 3.0mm x 12mm |
| 1 x | 3.0mm x 13mm |
| 1 x | 3.0mm x 14mm |
| 1 x | 3.0mm x 15mm |
| 1 x | 3.5mm x 9mm |
| 1 x | 3.5mm x 11mm |
| 1 x | 3.5mm x 17mm |
| 1 x | 3.5mm x 18mm |
| 1 x | 4.0mm x 12mm |
| 1 x | 4.0mm x 13mm |
| 1 x | 4.0mm x 14mm |
| 1 x | 4.0mm x 17mm |
| 1 x | 4.0mm x 19mm |
| 2 x | Poly tube (4.5mm flange) |
| 5 x | Nylon cleaning rods |
| 1 x | Gold dilator No.1 |
| 1 x | Gold dilator No.2 |



0112052



0110045



0112056



0110046

0110047

Lester Jones support products

| | | |
|---------|--|-----------|
| 0110045 | Nylon cleaning rod | |
| 0110046 | Jones gold dilator No.1 double ended 1.7mm and 1.9mm | Gold |
| 0110047 | Jones gold dilator No.2 double ended 2.2mm and 2.4mm | Gold |
| 0112052 | Storage tray with 28 labelled cups for tubes, plus storage for gold dilators, cleaning rods and poly tubes | Plastic |
| 0112055 | Sterilisation tray with 28 labelled cups for tubes, plus storage for gold dilators, cleaning rods and poly tubes | Aluminium |
| 0112056 | Measuring Scale for measuring both length and diameter with accuracy | Aluminium |

Lacrimal Implants

DCR intubation sets (sterile, box of 2)



0111026

DCR intubation bodkin, double ended with 2 x round tipped, angled 44mm bodkins (25mm tip to angle), attached to 500mm of silicone, latex free tubing



0111028

DCR intubation bodkin, double ended with 2 x round tipped, straight 44mm bodkins, attached to 300mm of silicone, latex free tubing

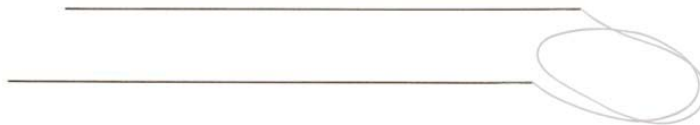

0111027

Weiss intubation set, double ended with 2 x round tipped, straight 185mm bodkins, attached to 300mm of silicone, latex free tubing



0111029

Crawford intubation set, double ended with 2 x olive tipped, straight 152mm bodkins, attached to 300mm of silicone, latex free tubing. Retrieval device included

Retractors, Hooks & Specula

0206020 SS

Killian nasal speculum, adjustable with 50mm blades, maximum opening 30mm, overall length 140mm



0107057 SS

Stevenson lacrimal sac retractor, adjustable with 10mm blades each with 3 prongs, maximum opening 20mm, overall length 82mm



0107092 SS

Fison retractor with 20mm deep angled blade, 11mm wide, overall length 130mm



0107072 SS

Watson orbital retractors, maleable.

Available as a set of 4 or individually as below.

0107073 SS

Watson maleable orbital retractor, single 8mm x 30mm blade, overall length 152mm

0107074 SS

Watson maleable orbital retractor, large with 2x 4mm x 42mm pronged blades, overall length 162mm

0107075 SS

Watson maleable orbital retractor, medium with 2x 4mm x 36mm pronged blades, overall length 156mm

0107076 SS

Watson maleable orbital retractor, small with 2x 4mm x 24mm pronged blades, overall length 145mm



Retractors, Hooks & Specula



0107014 SS

Desmarres lid retractor, large with 15mm blade, overall length 140mm



0107013 SS

Desmarres lid retractor, medium with 13mm blade, overall length 140mm



0107012 SS

Desmarres lid retractor, small with 12mm blade, overall length 140mm



0104132 SS

Jaffe lid retractor, small with 10mm open wire blade, overall length 40mm. Comes as a pair



0104133 SS

Jaffe lid retractor, large with 15mm open wire blade, overall length 40mm. Comes as a pair



0107052 SS

Knapp retractor, straight with 4 x 5mm rounded, hooked prongs, overall length 133mm



0107059 SS

Rollet retractor, straight with 4x 4mm sharp, hooked prongs, overall length 135mm

Retractors, Hooks & Specula

0105082 **SS**

Maidstone oculoplastic hook for lateral canthoplasty with fenestration at tip. 13mm hook, overall length 138mm



0105080 **SS**

Assaf muscle hook, adult, flat grooved 7mm hook, overall length 145mm



0105081 **SS**

Assaf muscle hook, child, flat grooved 5mm hook, overall length 145mm



0105102 **SS**

Kilner hook, straight with a 3mm sharp pointed hook, overall length 140mm



0202352 **SS**

Gilles skin hook small, straight with a 3mm sharp pointed hook, overall length 185mm



0202354 **SS**

Gilles skin hook large, straight with a 4mm sharp pointed hook, overall length 185mm



Chisels & Osteotomes



0114087 SS



0114105 SS



0114144 SS

| | Description | Tip width | Length | Shape | |
|----------------|-------------|-----------|--------|----------|-----------|
| 0114084 | Chisel | 3mm | 180mm | straight | SS |
| 0114085 | Chisel | 4mm | 180mm | straight | SS |
| 0114086 | Chisel | 5mm | 180mm | straight | SS |
| 0114087 | Chisel | 6mm | 180mm | straight | SS |
| 0114088 | Chisel | 7mm | 180mm | straight | SS |
| 0114103 | Chisel | 3mm | 180mm | curved | SS |
| 0114104 | Chisel | 4mm | 180mm | curved | SS |
| 0114105 | Chisel | 5mm | 180mm | curved | SS |
| 0114106 | Chisel | 6mm | 180mm | curved | SS |
| 0114107 | Chisel | 7mm | 180mm | curved | SS |
| 0114143 | Osteotomes | 3mm | 180mm | straight | SS |
| 0114144 | Osteotomes | 4mm | 180mm | straight | SS |
| 0114145 | Osteotomes | 5mm | 180mm | straight | SS |
| 0114146 | Osteotomes | 6mm | 180mm | straight | SS |
| 0114147 | Osteotomes | 7mm | 180mm | straight | SS |

Weiss Sphenoidal Punches

| | | Bite size | Cut direction | Shape | Shaft length | |
|----------------|--|-----------|---------------|----------|--------------|-----------|
| 0101487 | Weiss sphenoidal punch, fine | 2mm | Up | Straight | 140mm | SS |
| 0101488 | Weiss sphenoidal punch, fine | 2mm | Down | Straight | 140mm | SS |
| 0101485 | Weiss sphenoidal punch | 3mm | Up | Straight | 140mm | SS |
| 0101495 | Weiss sphenoidal punch, fine with curved cup | 3mm | Up | Straight | 140mm | SS |
| 0101490 | Weiss sphenoidal punch, fine | 3mm | Down | Straight | 140mm | SS |
| 0101483 | Weiss sphenoidal punch | 4mm | Up | Straight | 140mm | SS |
| 0101494 | Weiss sphenoidal punch, fine | 4mm | Up | Straight | 140mm | SS |
| 0101484 | Weiss sphenoidal punch | 4mm | Down | Straight | 140mm | SS |
| 0101493 | Weiss sphenoidal punch, fine | 4mm | Down | Straight | 140mm | SS |



Other sized punches may be made to order, please contact us for more information

Kerrison Punch

| | | Bite size | Cut direction | Tip angle | Overall length | |
|----------|--|-----------|---------------|-----------|-----------------------|----|
| 0204155 | Kerrison punch | 2mm | up | 40 degree | choose 180mm or 200mm | SS |
| 0204155T | Kerrison punch - thin | 2mm | up | 40 degree | choose 180mm or 200mm | SS |
| 0204158 | Kerrison punch - take apart with ejector | 2mm | up | 40 degree | choose 180mm or 200mm | SS |
| 0204158T | Kerrison punch - thin - take apart with ejector | 2mm | up | 40 degree | choose 180mm or 200mm | SS |
| 0104163 | Kerrison punch - with ejector | 2mm | up | 40 degree | choose 180mm or 200mm | SS |
| 0104163T | Kerrison punch - thin - with ejector | 2mm | up | 40 degree | choose 180mm or 200mm | SS |
| 0204159 | Kerrison punch - take apart with ejector | 3mm | up | 40 degree | choose 180mm or 200mm | SS |
| 0204159T | Kerrison punch - thin - take apart with ejector | 3mm | up | 40 degree | choose 180mm or 200mm | SS |
| 0204164 | Kerrison punch - with ejector | 3mm | up | 40 degree | choose 180mm or 200mm | SS |
| 0204164T | Kerrison punch - thin - with ejector | 3mm | up | 40 degree | choose 180mm or 200mm | SS |
| 0204156 | Kerrison punch | 3mm | down | 90 degree | choose 180mm or 200mm | SS |
| 0204156T | Kerrison punch - thin | 3mm | down | 90 degree | choose 180mm or 200mm | SS |
| 0204157 | Kerrison punch | 4mm | up | 90 degree | choose 180mm or 200mm | SS |
| 0204157T | Kerrison punch - thin | 4mm | up | 90 degree | choose 180mm or 200mm | SS |
| 0204160 | Kerrison punch - take apart with ejector | 4mm | up | 40 degree | choose 180mm or 200mm | SS |
| 0204160T | Kerrison punch - thin - take apart with ejector | 4mm | up | 40 degree | choose 180mm or 200mm | SS |
| 0204165 | Kerrison punch - with ejector | 4mm | up | 40 degree | choose 180mm or 200mm | SS |
| 0204165T | Kerrison punch - thin - with ejector | 4mm | up | 40 degree | choose 180mm or 200mm | SS |
| 0204161 | Kerrison punch - take apart with ejector | 5mm | up | 40 degree | choose 180mm or 200mm | SS |
| 0204161T | Kerrison punch - thin - take apart with ejector | 5mm | up | 40 degree | choose 180mm or 200mm | SS |
| 0204166 | Kerrison punch - with ejector | 5mm | up | 40 degree | choose 180mm or 200mm | SS |
| 0204166T | Kerrison punch - thin - with ejector | 5mm | up | 40 degree | choose 180mm or 200mm | SS |
| 0204162 | Kerrison punch - take apart with ejector | 6mm | up | 40 degree | choose 180mm or 200mm | SS |
| 0204162T | Kerrison punch - thin - take apart with ejector | 6mm | up | 40 degree | choose 180mm or 200mm | SS |
| 0204167 | Kerrison punch - with ejector | 6mm | up | 40 degree | choose 180mm or 200mm | SS |
| 0204167T | Kerrison punch - thin - with ejector | 6mm | up | 40 degree | choose 180mm or 200mm | SS |



Other sized punches may be made to order, please contact us for more information

Orbital instruments

Downs Rootman Orbital Surgery

0107112 SS 27

Downs Rootman Orbital Surgery Set

The set contains 1 or more of each of the instruments listed on pages 88-90. Instrument numbers included in the set are shown in the blue box.

Tray, code number: **0112004**, is recommended.

Please note that all instruments are available individually.



0107132 SS 1

Tumour holding forceps, straight with 2mm square, notched jaws, overall length 158mm



0107131 SS 1

Tumour holding forceps, straight with fenestrated, cupped jaws, 7mm x 10mm, overall length 160mm



0107130 SS 1

Tumour holding hook, 5mm long, 90°, blunt, overall length 160mm



0107129 SS 1

Tumour holding hook, 5mm long, 90°, sharp, overall length 160mm



0107128 SS 1

Vessel retractor, 'U' shaped, 8mm, curved, overall length 150mm



0107127 SS 1

Dissector/elevator, curved with 5mm crescent shaped end, overall length 150mm



Orbital instruments

Downs Rootman Orbital Surgery



0107126 SS 1

Dissector/elevator, curved with 4mm circular shaped end, overall length 150mm



0107125 SS 1

Dissector/elevator, curved with 3mm circular shaped end, overall length 150mm



0107124 SS 1

Dissector/elevator, straight with 30° angled, circular shaped end, overall length 150mm



0107123 SS 1

Retractor, Temporal Fossa, right, curved with 40mm blade, overall length 155mm



0107122 SS 1

Retractor, Temporal Fossa, left, curved with 40mm blade, overall length 155mm



0107121 SS 1

Periosteal elevator, straight, 5mm wide, slightly curved tip, overall length 150mm



0107120 SS 1

Periosteal elevator, straight, 7.5mm wide, round tip, overall length 150mm

Orbital instruments

Downs Rootman Orbital Surgery

0107119 **ss** **1**

Periosteal elevator, straight, double ended,
8mm x 12mm hockey sticks, left & right,
overall length 182mm



0107118 **ss** **4**

Skin retractor, 5mm wide, serrated, hook shaped,
overall length 30mm



0107117 **ss** **2**

General retractor, curved, 15mm wide,
overall length 166mm



0107116 **ss** **2**

General retractor, curved, 8mm wide,
overall length 166mm



0107115 **ss** **1**

Retractor, flared end, angled, 14mm x 32mm deep,
overall length 160mm



0107114 **ss** **2**

Retractor, angled, 7mm x 16mm deep,
overall length 160mm



0107113 **ss** **2**

Retractor, angled, 7mm x 10mm deep,
overall length 160mm



Enucleation / Evisceration



0106045 SS

Trelat enucleation spatula, straight with a slotted, 18mm cup, overall length 150mm



0114240 SS

Mule evisceration scoop, straight with a 11mm wide, smooth, curved blade, overall length 110mm



0114241 SS

Elliot evisceration scoop, straight with a 13mm x 30mm spoon, overall length 146mm



0120303 SS

Moorfields globe introducer, with 12mm wide, curved jaws for holding wright globe, overall length 110mm



0114325 SS

Foster enucleation snare with 26G wire, overall length 120mm



0114326 SS

29G replacement wire for Foster snare x 2 metres

0114327 SS

26G replacement wire for Foster snare x 2 metres

Orbital Implants

Wright Globe – Acrylic



| | |
|----------------|------|
| 7200030 | 12mm |
| 7200031 | 14mm |
| 7200032 | 16mm |
| 7200033 | 18mm |
| 7200034 | 20mm |
| 7200035 | 21mm |
| 7200036 | 22mm |

Wright Globes are available sterile wrapped in single units from Spring 2017

Miscellaneous



0120311 SS

Zoellner suction tube, angled with 45mm tip to angle length, overall length 150mm



0120308 SS

Friedman bone nibbler forceps, curved with 2mm x 10mm cup, overall length 135mm



0114029 SS

Rollet rugine, straight with 5mm wide tip, overall length 116mm



0114299 SS

Rollet rugine & periosteal elevator, double ended, 4mm straight rugine & 3mm angled elevator, 4.5mm tip to angle, overall length 158mm



0114262 SS

Freer elevator double ended, slightly curved with 1x 4.5mm sharp end & 1x 4.5mm blunt end, overall length 182mm



0114263 SS

Traquair periosteal elevator, double ended with 1x 3mm wide, 7mm tip to angle & 1x 2mm wide, 5mm tip to angle, overall length 155mm



0114264 SS

Howarth periosteal elevator & rugine, double ended with 7mm wide, straight elevator & 5mm curved rugine, overall length 215mm

Miscellaneous

0114162 **SS**

Stallard dissector, double ended, straight with 1x 2mm end and 1x 3mm end, overall length 140mm



0114312 **SS**

Mallet, double headed with 55mm round heads, overall length 210mm



0114198 **SS**

Scalpel handle No. 9 (takes No.11 blades), overall length 115mm



0114200 **SS**

Scalpel handle No. 3 (takes No.15 blades), overall length 120mm



0114197 **SS**

No.11 scalpel blades box of 100



0114199 **SS**

No.15 scalpel blades box of 100



Specialist Instruments

General, Vitreoretinal, Corneal and Refractive, Cataract, Glaucoma, Diamond Knives, Corneal knives, Trephines, Trays.

Veterinary: Ophthalmic, Exotic & small animal



Some specialist areas of surgery such as Corneal, Cataract, Glaucoma, Refractive, Vitreoretinal and Veterinary (Ophthalmic and Small & Exotic animals) require instrumentation specific to the demands of their particular surgery. Please contact us if you don't see what you want as new instruments are being developed all the time

Using microsurgical instruments

Although most damage occurs to instruments during processing and cleaning, it is important to make sure that they are also handled correctly during the surgical procedure. Here are some guidelines, please note that these are of a general nature and are not intended to replace any country or institution specific protocol or procedures.

- Always keep microsurgical instruments in a purpose designed tray while not actually in use and never allow them to lay loose together on the trolley.
- Only use trays designed specifically for microsurgical instruments as standard instrument trays may not offer adequate grip for such delicate instruments or may damage them by applying too much pressure in the wrong place.
- Carefully inspect all instruments under magnification before and after use.
- Only people who are trained in the use of microsurgical instruments should handle them e.g. surgeons and specialist practitioners
- Instruments should only be used for their intended purpose, anything else e.g. cutting a drape with Westcott scissors, may damage them.
- Never pick up instruments by tips or let tips touch anything other than the tissue they are designed for. This prevents both damage to the instrument and injury to the user.
- Do not let the tips touch the trolley drape, it may damage the fine points or teeth, and if the drape has fibres, these may be transferred to the instrument tips.
- When no longer in use, wipe clean with demineralised/sterile water and thoroughly flush through any lumen with cool demineralised/sterile water, this will prevent proteinaceous material from sticking to the instrument.
- Scalpel blades, knives and scissors require particular care
 - if the instrument does not have a blade cover it must be passed between practitioners by the handle so that the cutting edge, and the point, face downwards. This must be done with great care to prevent injury.
 - If available with a blade cover, a knife or scalpel should be passed between practitioners with the blade sheathed and by the handle. The user should then un-sheath the blade, use it, then re-sheath before passing the knife back. Care should still be taken even though the blade is protected.
 - particular care should be taken when removing a blade from a scalpel handle, this should never be done using the fingers, instead artery forceps should be used and the blade removed, angled away from the practitioner's body.
- Get to know the names of the instruments within a set as well as the specific instruments used for each procedure and the general order in which they are used. Following the procedure will enable anticipation of the next instrument required and give time to locate and prepare it.
- Avoid stainless steel instruments from coming into contact with any magnetised objects as this may transfer to them making their use difficult e.g. suture needles may be difficult to let go of when a stainless steel needle holder becomes magnetised.
- Cleaning and sterilisation should be performed by those qualified to do so. For our most up-to-date guidelines visit

www.johnweiss.com



0120283 SS

Castroviejo caliper and rule, double sided with 20mm scale in 0.5mm increments



0120284 SS

Standard 150mm / 6 inch ruler



0114298

Foreign body needle (sharp 1mm x 7mm) and spud (straight, round 1mm x 24mm) double ended with protective caps, overall length 118mm



0204132 SS

Adson forceps, straight with 10mm serrated tips, overall length 122mm



0204134 SS

Adson forceps, straight with 0.5mm teeth, overall length 122mm

General

0101462 SS

Serrafine cross action mini clamp, straight.
10mm serrated jaws, overall length 38mm



0101463 SS

Serrafine cross action, featherweight, mini clamp,
straight. 8mm serrated jaws, overall length 32mm



0101464 SS

Serrafine cross action, mini clamp, curved.
16mm serrated jaws, overall length 48mm



0103275 SS

Good utility scissors for cutting drape, ribbon style,
straight with rounded tips. Max cutting length
18mm, blade length 26mm, overall length 103mm



0103276 SS

Good utility scissors for cutting drape, ribbon
style, curved with rounded tips. Max cutting
length 18mm, blade length 26mm, overall length
102mm





0101589 SS

Towel clamp, cross action, straight,
overall length 85mm



0101583 SS

Towel clamp, non-penetrating, curved,
5mm ball & socket tip, overall length 90mm



0204136 SS

Ramsey's sponge forceps, straight, 26mm
serrated tips, overall length 182mm



0204147 SS

Backhaus towel clamp, curved, overall length
89mm

General

0101472 **SS**

Halstead mosquito forceps, straight with 20mm serrated tips, overall length 125mm



0101473 **SS**

Halstead mosquito forceps, curved with 20mm serrated tips, overall length 125mm



0101474 **SS**

Wells artery forceps, straight with 20mm serrated tips, overall length 95mm



0101475 **SS**

Wells artery forceps, curved with 20mm serrated tips, overall length 95mm



Vitreoretinal



0109522 Ti

Schocket scleral depressor/ indenter with pocket clip. Double ended 1x smooth olive tip 1x smooth 5mm 'T' bar, overall length 137mm



2003069 SS

Vitreoretinal flushing system for effective irrigation of V/R instruments, overall length 132mm



0101605 SS

Scleral plug forceps, cross action, angled tips have a 2mm groove for gripping scleral plug. 8mm tip to angle, overall length 106mm



0101552 SS

Watski sleeve forceps, reverse cross action for applying sleeve to retinal bands. Curved tips, overall length 116mm

Corneal and Refractive

1501121 Ti

Keratometer, hand held. Proximal diameter 9mm, distal diameter 29mm, overall length 20mm*

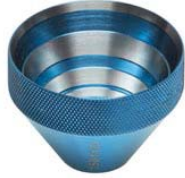

1501038 SS

Refractive zone marker, crosshair, 8mm, overall length 105mm*



1501126 Ti

Refractive radial marker, 8 blade, overall length 126mm*



1501094 Ti

Fine-Thornton swivel fixation ring with 15° markings. 13mm diameter with 11 blunt teeth and gap, overall length 135mm*



* Other sizes available on request

Corneal and Refractive



0109526 Ti

Weiss lasik flap lifter, double ended and angled, 1 x sharp pointed and 1 x spatulated. 10mm tip to angle, overall length 135mm



0109532 Ti

Bristol spatula with 10mm x 15mm depression, overall length 130mm



0114322 SS

Flieringa scleral rings, set of six. One each of 13mm, 15mm, 17mm, 19mm, 21mm and 23mm diameter



0111041

Silicone punch block with 14mm central depression, overall diameter 30mm



0109530 Ti

Nischal corneal gauge. Set of three discs with sizes 6.5mm to 19mm in 0.5mm increments

Cataract

0109520 Ti

Weiss IOL cutter, with a 2.6mm diameter it effectively and safely cuts foldable IOL's through a small incision, overall length 130mm. Sterilisation tray included.



2001001 Ti

Weiss capsular tension ring injector, curved, for use with Morcher style CTR's, overall length 152mm



0109181 Ti

Felipe fixation forceps, reverse cross action for fixating the eye during phaco. Angled, 12mm tip to angle, overall length 106mm



0109448 Ti

IOL loading forceps, angled with atraumatic rounded tips and jaws, 15mm tip to angle, overall length 105mm



0109449 Ti

IOL loading forceps, straight with atraumatic rounded tips and jaws, 15mm jaws, overall length 110mm

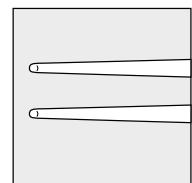
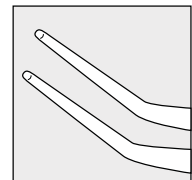

Glaucoma



0101491 **SS**

Kelly punch with protective cap. Squeeze action with 1mm tip for cutting Descemet's membrane, overall length 130mm



0101492 **SS**

Replacement cap for 0101491 Kelly punch



0101497 **Ti**

23G squeeze action trabeculectomy punch with angled 0.6mm cutter, overall length 135mm



0101496 **SS**

Luntz-Dodick trabeculectomy punch with angled, 4 position 1mm cutter, overall length 116mm

Diamond Knives

Straight

Overall length 110mm (not including blade)

All Diamond Knives are supplied with a sterilisation tray



0113052 Ti

45° blade, 1mm wide

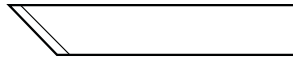

0113053 Ti

Trifacet blade, 1mm wide



0113054 Ti

30° blade, 1mm wide



0113055 Ti

60° lance blade, 1.4mm wide

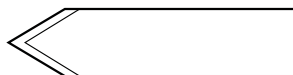

0113056 Ti

90° spear blade (keratome), 1.4mm wide

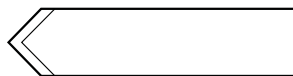

Diamond Knives

90 degree angled

Overall length 110mm (not including blade)

All Diamond Knives are supplied with a sterilisation tray



Phaco spear (keratome)



- 3.2mm wide 0113072 Ti
- 3.0mm wide 0113073 Ti
- 2.8mm wide 0113074 Ti
- 2.5mm wide 0113075 Ti

Phaco spear (keratome) for clear corneal incision

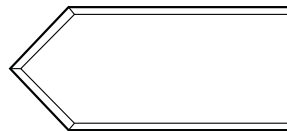

- 3.2mm wide 0113076 Ti
- 3.0mm wide 0113077 Ti
- 2.8mm wide 0113078 Ti
- 2.5mm wide 0113079 Ti
- 2.2mm wide 0113082 Ti

Nine edged crescent blade

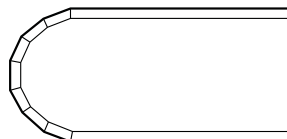

- 3.0mm wide 0113084 Ti
- 2.0mm wide 0113085 Ti

Corneal knives

0114022 **SS**

Tooke knife, straight with 15mm x 2.5mm crescent blade for corneal scraping or splitting, overall length 115mm



0114025 **SS**

Desmarres corneal knife small, straight with 10mm x 4mm hockey stick blade, overall length 130mm



0114026 **SS**

Desmarres corneal knife medium, straight with 10mm x 4.5mm hockey stick blade, overall length 130mm



0114027 **SS**

Desmarres corneal knife large, straight with 10mm x 5mm hockey stick blade, overall length 130mm



General Knives

0114197 **SS**

No.11 sterile scalpel blades box of 100



0114199 **SS**

No.15 sterile scalpel blades box of 100



0114198 **SS**

Scalpel handle No. 9 (takes No.11 blades), overall length 115mm

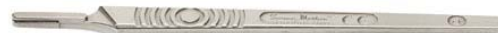

0114200 **SS**

Scalpel handle No. 3 (takes No.15 blades), overall length 120mm



Trephines

sold sterile, box of 2



| | | | Diameter |
|---------|----|-----------------------------|----------|
| 0111077 | SS | Standard trephine 20mm long | 6.0mm |
| 0111078 | SS | Standard trephine 20mm long | 6.25mm |
| 0111079 | SS | Standard trephine 20mm long | 6.5mm |
| 0111080 | SS | Standard trephine 20mm long | 6.75mm |
| 0111081 | SS | Standard trephine 20mm long | 7.0mm |
| 0111082 | SS | Standard trephine 20mm long | 7.25mm |
| 0111083 | SS | Standard trephine 20mm long | 7.5mm |
| 0111084 | SS | Standard trephine 20mm long | 7.75mm |
| 0111085 | SS | Standard trephine 20mm long | 8.0mm |
| 0111086 | SS | Standard trephine 20mm long | 8.25mm |
| 0111087 | SS | Standard trephine 20mm long | 8.5mm |
| 0111088 | SS | Standard trephine 20mm long | 8.75mm |
| 0111089 | SS | Standard trephine 20mm long | 9.0mm |
| 0111091 | SS | Standard trephine 20mm long | 9.25mm |
| 0111092 | SS | Standard trephine 20mm long | 9.50mm |

| | | | |
|---------|----|---------------------------------|--------|
| 0111137 | SS | Long Handled trephine 75mm long | 6.5mm |
| 0111138 | SS | Long Handled trephine 75mm long | 6.75mm |
| 0111139 | SS | Long Handled trephine 75mm long | 7.0mm |
| 0111140 | SS | Long Handled trephine 75mm long | 7.25mm |
| 0111141 | SS | Long Handled trephine 75mm long | 7.5mm |
| 0111142 | SS | Long Handled trephine 75mm long | 7.75mm |
| 0111143 | SS | Long Handled trephine 75mm long | 8.0mm |
| 0111144 | SS | Long Handled trephine 75mm long | 8.25mm |
| 0111145 | SS | Long Handled trephine 75mm long | 8.5mm |
| 0111146 | SS | Long Handled trephine 75mm long | 8.75mm |
| 0111147 | SS | Long Handled trephine 75mm long | 9.0mm |
| 0111148 | SS | Long Handled trephine 75mm long | 9.25mm |
| 0111149 | SS | Long Handled trephine 75mm long | 9.5mm |

Trays

Polymer – removable lid

0112013

Tray holds 10 instruments with silicone finger matting. Outer size W260mm D160mm H25mm. Inner size W250mm D150mm H20mm.

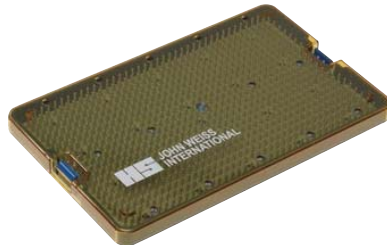

0112015

Tray holds 20 instruments with silicone finger matting. Outer size W390mm D265mm H25mm. Inner size W380mm D250mm H20mm.



0112014

Tray, 2 tier, holds 20 instruments with silicone finger matting. Outer size W260mm D160mm H45mm. Inner size W250mm D150mm H40mm.

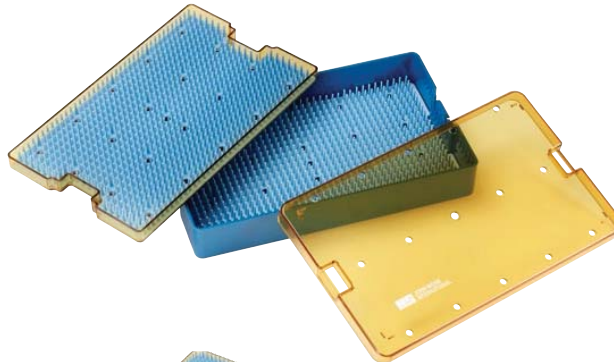

0112019

Tray, 2 tier, holds 40 instruments with silicone finger matting. Outer size W390mm D270mm H45mm. Inner size W380mm D255mm H40mm.

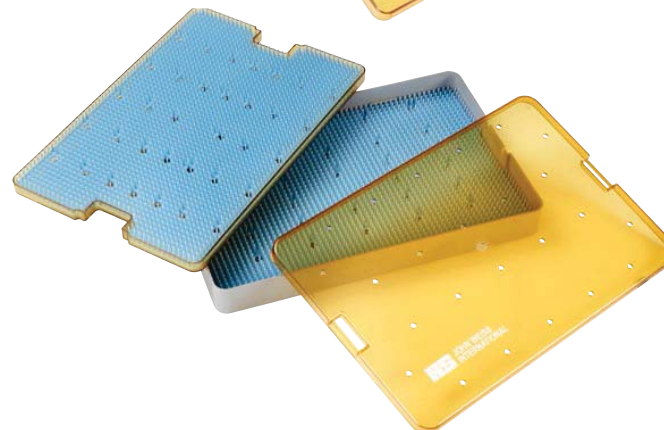

Trays

Polymer – removable lid

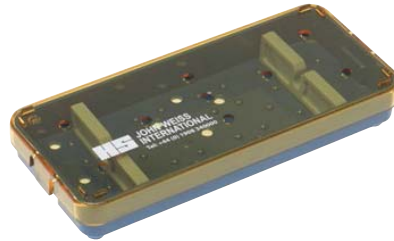

0112012

Diamond Knife tray with silicone grip for 1 knife. Outer size W160mm D70mm H25mm. Inner size W150mm D60mm H20mm.

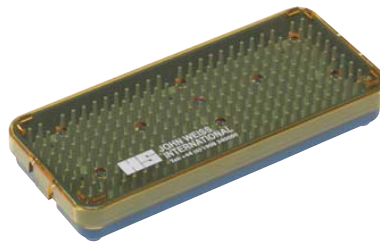

0112016

Tray holds 1 - 2 instruments with silicone finger matting. Outer size W160mm D70mm H25mm. Inner size W150mm D60mm H20mm.



0112017

Tray holds 3 instruments with silicone finger matting. Outer size W175mm D110mm H25mm. Inner size W160mm D100mm H20mm.



0112018

Tray holds 3 instruments with silicone finger matting. Outer size W200mm D110mm H25mm. Inner size W190mm D100mm H20mm.

Number of instruments per tray is a guide only.

Trays

Metal – removable lid

0112003

Tray holds 12 instruments with 3 strips of silicone finger matting. Outer size W220mm D210mm H30mm. Inner size W200mm D200mm H25mm.



0112002

Tray holds 20 instruments with 4 strips of silicone finger matting. Outer size W385mm D270mm. H30mm Inner size W365mm D260mm H25mm.



0112004

Tray with 2 areas. Area 1 holds 20 instruments with 4 strips of silicone finger matting.

Size W280mm D260mm H25mm.

Area 2 With silicone finger matting accommodates larger items such as a phaco handpiece, size W260mm D160mm H50mm.

Total size of tray outer W510mm D270mm H70mm. Inner W500mm D260mm H65mm.



Number of instruments per tray is a guide only.

VETERINARY OPHTHALMIC INSTRUMENTS

The following section shows basic veterinary surgery sets and recommended additions you may wish to add to a set.

Please contact us if you require further information.

John Weiss would like to thank all the staff at the Eye Veterinary Clinic, Leominster, Herefordshire and Iain Cope BSc (VetSci)Hons BVM&S CertAVP(ZooMed) MRCVS for their help and advice in putting together this selection of instrumentation

Small & exotic animal surgery

Basic Set

Recommended number of instruments per basic set are shown in the blue box

0101285 SS 1



0101298 SS 1



0101543 SS 1



0204134 SS 1



0204132 SS 1



0101472 SS 3



0101473 SS 3



0101464 SS 2



0101462 SS 2



0103204 SS 1



0103203 SS 1



0114200 SS 1



0104136V SS 1

Cope retractor, adjustable with solid 14mm x 5mm blades. Maximum opening 40mm, overall length 75mm



| CODE | | NAME | FUNCTION | ANIMAL | No* | PAGE No |
|----------|----|---|------------------------------|----------|-----|---------|
| 0101285 | SS | Francis toothed forceps | General use | R Mc P K | 1 | 18 |
| 0101298 | SS | Graefe locking forceps | Muscle gripping | ALL | 1 | 18 |
| 0101543 | SS | Moorfields serrated forceps | General use | ALL | 1 | 1 |
| 0204134 | SS | Adsons toothed forceps | General use | R Mc P K | 1 | 17 |
| 0204132 | SS | Adsons serrated forceps | General use | R Mc P K | 1 | 4 |
| 0101472 | SS | Halsted Mosquito forceps, straight | Haemostasis | R Mc P K | 3 | 29 |
| 0101473 | SS | Halsted Mosquito forceps, curved | Haemostasis | R Mc P K | 3 | 29 |
| 0101464 | SS | Serrafine clip, curved | Suture clip | ALL | 2 | 31 |
| 0101462 | SS | Serrafine clip, fine, straight | Suture gripping | ALL | 2 | 31 |
| 0103204 | SS | Excision scissors, straight with rounded tips | General use | R Mc P K | 1 | 49 |
| 0103203 | SS | Excision scissors, curved with rounded tips | General use | R Mc P K | 1 | 49 |
| 0104136V | SS | Cope retractor, screw action | Self retaining | H B | 1 | 113 |
| 0112014 | | Instrument tray 260mm x 160mm x 45mm | Holds approx. 20 instruments | ALL | 1 | 108 |
| 0114200 | SS | Scalpel blade handle #3 | for No.15 blades | ALL | 1 | 94 |

* Recommended number of instruments per basic set

ANIMAL KEY: Rabbit (R) Macaw (Mc) Puppy (P) Kitten (K) Hamster (H) Budgerigar (B) Snake (S) Mouse (M)

0112014 SS 1

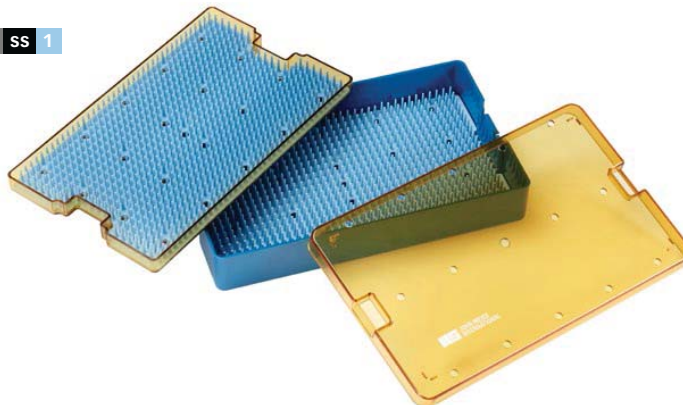

SEE FOLLOWING PAGES FOR RECOMMENDED ADDITIONS TO THE BASIC SET

Small & exotic animal surgery

Micro Extras

Addition of the following will allow for surgery on smaller animals such as budgerigars, hamsters and mice

| CODE | | NAME | FUNCTION | ANIMAL | No* | Page No |
|---------|----|--|----------------|--------|-----|---------|
| 0101290 | SS | Elschnig toothed forceps | General use | H B | 1 | 18 |
| 0101047 | SS | Castroviejo toothed forceps | General use | H B | 1 | 17 |
| 0101015 | SS | Castroviejo platform forceps | Suture tying | H B | 1 | 7 |
| 0101474 | SS | Wells artery forceps, straight | Haemostasis | H B | 2 | 29 |
| 0101475 | SS | Wells artery forceps, curved | Haemostasis | H B | 2 | 29 |
| 0103227 | SS | Scissors, straight with sharp pointed tips | General use | All | 1 | 48 |
| 0104135 | SS | Sauer spring speculum | Self retaining | H B | 1 | 64 |

* Recommended number of instruments required

Miscellaneous Extras – Disposables

| CODE | NAME | QUANTITY | ANIMAL | Page No |
|---------|-----------------------------|----------|----------|---------|
| 1701002 | Swabsticks 5/pkt | 20/box | All | 125 |
| 1701003 | Swabsticks 10/pkt | 20/box | All | 125 |
| 0111008 | Swab strips 10/pkt | 20/box | All | 125 |
| 0111122 | Disposable low heat cautery | 10/box | All | 128 |
| 1601095 | Mini drape 400x400mm | 10/box | All | 124 |
| 1601071 | Medium drape with bag | 10/box | R Mc P K | 124 |

ANIMAL KEY: Rabbit (R) Macaw (Mc) Puppy (P) Kitten (K) Hamster (H) Budgerigar (B) Snake (S) Mouse (M)

| CODE | | NAME | FUNCTION | ANIMAL | Page No |
|---------|----|--|----------------------------------|----------|---------|
| 0104133 | SS | Jaffe retractors, pair of large | Attach string to make adjustable | R Mc P K | 68 |
| 0104132 | SS | Jaffe retractors, pair of small | Attach string to make adjustable | H B | 65 |
| 0103106 | SS | Vannas scissors, curved | Ultra fine | H B | 41 |
| 0103105 | SS | Vannas scissors, straight | Ultra fine | HB | 40 |
| 0103182 | SS | Westcott scissors, curved with wide handle and rounded tips | Blunt dissection | R Mc P K | 42 |
| 0103172 | SS | Westcott scissors, curved with fine rounded tips | General use | R Mc P K | 42 |
| 0102002 | SS | Castroviejo needle holder, straight, locking | Suturing | All | 36 |
| 0102005 | SS | Castroviejo needle holder, with straight heavy jaws, locking | Suturing | All | 36 |
| 0120283 | SS | Caliper & rule | Measuring | All | 95 |
| 0107012 | SS | Desmarres retractor, small 12mm blade | Tissue retractor | H B | 83 |
| 0107013 | SS | Desmarres retractor, medium 13mm blade | Tissue retractor | All | 83 |
| 0107014 | SS | Desmarres retractor, large 15mm blade | Tissue retractor | R Mc P K | 83 |
| 0107052 | SS | Knapp retractor with 4 blunt prongs | Tissue retractor | All | 83 |
| 0107059 | SS | Rollet retractor with 4 sharp prongs | Tissue retractor | All | 83 |
| 0107092 | SS | Fison retractor with 20mm blade | Deep retraction | R Mc P K | 82 |
| 0120311 | SS | Zoellner suction tube, fine | Suction | All | 93 |
| 0108032 | SS | Bulbous end cannula 19G, curved, 40mm overall length | Irrigation of sinuses, ducts etc | All | - |
| 0114215 | SS | Sharp spoon, small 3x2.2mm cup | Curette | All | 71 |
| 0114216 | SS | Sharp spoon, medium 3.8x2.7mm cup | Curette | All | 71 |
| 0114217 | SS | Sharp spoon, large 4.6x3mm cup | Curette | All | 71 |
| 0114218 | SS | Sharp spoon, extra large 5.7x3.7mm cup | Curette | All | 71 |
| 0108062 | SS | Snellen vectis probe | removal of stones, eggs etc | All | 62 |
| 0108064 | SS | Landolt vectis probe | removal of stones, eggs etc | H B | 62 |
| 0108070 | SS | Fine vectis probe | removal of stones, eggs etc | All | 62 |
| 0105072 | SS | Graefe hook, small | Tortoise head retractor | K | 60 |
| 0120308 | SS | Friedman bone nibbler, curved | | R Mc P K | 93 |
| 0114312 | SS | Mallet | | All | 94 |
| 0114299 | SS | Rollet double ended rugine / periosteal elevator | | All | 93 |
| 0114262 | SS | Freer double ended sharp / blunt periosteal elevator | | All | 93 |
| 0114263 | SS | Traquair double ended periosteal elevator | | All | 93 |
| 0114084 | SS | Straight chisel 3mm | | All | 85 |
| 0114086 | SS | Straight chisel 5mm | | All | 85 |
| 0114103 | SS | Curved chisel 3mm | | All | 85 |
| 0114105 | SS | Curved chisel 5mm | | All | 85 |
| 0114107 | SS | Curved chisel 7mm | | All | 85 |
| 0112013 | | Tray 250x150x20mm for approx 10 instruments | | | 108 |

Veterinary Ophthalmic Instruments

Extraocular

0101073 SS



0101043 SS



0101047 SS



0102009 SS



0103178 SS



0103179 SS



0103182 SS



0103270 SS



0105036 SS



0106048 SS



0101413 SS



0101474 SS



0101475 SS



0103275 SS



0114200 SS



0114198 SS



0108084 SS



For general surgery including lids, entropion/ectropion, 3 snip and removal of lid lesions

| CODE | | NAME | FUNCTION | Page No |
|---------|----|---|--------------------------------------|---------|
| 0101073 | SS | St Martin forceps 0.15mm teeth | Tissue holding e.g. conjunctiva | 15 |
| 0101043 | SS | St Martin forceps 0.3mm teeth | Tissue holding | 16 |
| 0101047 | SS | Castroviejo forceps 0.5mm teeth, wide handled | Tissue holding | 17 |
| 0102009 | SS | Castroviejo needle holder, curved, no catch | General suturing | 34 |
| 0103178 | SS | Stevens tenotomy scissors, straight with rounded tips | General use | 47 |
| 0103179 | SS | Stevens tenotomy scissors, curved with rounded tips | General use | 47 |
| 0103182 | SS | Westcott scissors, curved with rounded tips | General use spring scissors | 42 |
| 0103270 | SS | Fine sharp scissors | Punctum 3-snip | 50 |
| 0105036 | SS | Lacrimal dilator | Punctum finder/dilator | 77 |
| 0106048 | SS | Lid plate | Stabilise lid e.g. entropion surgery | 73 |
| 0101413 | SS | Chalazion clamp (Birmingham) | Excision chalazion/ lid lumps | 69 |
| 0114200 | SS | Scalpel blade handle #3 | For #15 blades | 94 |
| 0114198 | SS | Scalpel blade handle #9 | For #11 blades | 94 |
| 0101474 | SS | Wells artery forceps, straight | Haemostasis | 29 |
| 0101475 | SS | Wells artery forceps, curved | Haemostasis | 29 |
| 0103275 | SS | Utility scissors | Cutting drape etc. | 50 |
| 0108084 | | Bishop Harmon set (bulb & cannula) | Irrigating cornea | 117 |

Extras – the following instruments may be substituted or added to the extraocular set according to surgeon preference and range of surgery performed

| | | | | |
|---------|----|--|-----------------------------------|----|
| 0101543 | SS | Moorfields serrated forceps | General purpose forceps | 1 |
| 0204134 | SS | Adsons toothed forceps | General use | 17 |
| 0204132 | SS | Adsons serrated forceps | General use | 4 |
| 0204147 | SS | Backhaus towel clip | Fixing drape etc | 30 |
| 0104142 | SS | Lieberman K wire speculum | Adjustable lid speculum | 67 |
| 0101589 | SS | Towel clamp | Fixing drape etc | 30 |
| 0101472 | SS | Halsted Mosquito forceps, straight | Haemostasis | 29 |
| 0101473 | SS | Halsted Mosquito forceps, curved | Haemostasis | 29 |
| 0101464 | SS | Serrafine clip, curved | Suture gripping | 31 |
| 0101462 | SS | Serrafine clip, fine, straight | Suture gripping | 31 |
| 0109522 | Ti | Scleral indenter/depressor | Examination retina/retinal breaks | 99 |
| 0101265 | SS | Bennett cilia forceps | Epilation | 26 |
| 0120283 | SS | Caliper & rule | Accurate measurement | 95 |
| 0102002 | SS | Castroviejo needle holder, straight, locking | Suturing | 36 |
| 0102005 | SS | Castroviejo needle holder, with straight heavy jaws, locking | Suturing | 36 |

Veterinary Ophthalmic Instruments

Intraocular

0101073 SS



0103179 SS



0101015 SS



0104083 SS



0101009 SS



0101564 SS



0109316 Ti



0109222 Ti



0109301 Ti



0103019 SS



0103020 SS



0103040 SS



0103083 SS



0102064 SS



0108062 SS



0105074 SS



0108084 SS



For intraocular surgery such as cataract extraction, also suitable for corneal surgery

| CODE | | NAME | FUNCTION | Page No |
|---------|----|---|--------------------------------|---------|
| 0101073 | SS | St Martin forceps 0.15mm teeth | Tissue holding e.g. cornea | 15 |
| 0101079 | SS | Castroviejo colibri forceps 0.12mm teeth | Tissue holding | 14 |
| 0101015 | SS | Castroviejo forceps with platform | Suture tying | 7 |
| 0104083 | SS | Kratz barraquer speculum | Sliding / adjustable | 66 |
| 0101009 | SS | Rycroft forceps, straight | For IOL cartridge loading | 8 |
| 0101564 | SS | Utrata forceps | Capsulorhexis | 23 |
| 0109316 | Ti | Mushroom manipulator | Controlling lens nucleus/phaco | 55 |
| 0109222 | Ti | Drysdale manipulator | Controlling lens nucleus/phaco | 53 |
| 0109301 | Ti | Phaco chopper | Phaco chop technique | 51 |
| 0103019 | SS | Katzin corneal scissors | Right cutting | 44 |
| 0103020 | SS | Katzin corneal scissors | Left cutting | 44 |
| 0103040 | SS | Castroviejo corneal scissors | Miniature corneal scissors | 44 |
| 0103083 | SS | Long curved vannas scissors | Capsulotomy | 45 |
| 0102064 | SS | Troutman Tritt needle holder, curved no catch | Suturing | 35 |
| 0108062 | SS | Snellen Vectis | Lens support/removal | 62 |
| 0105074 | SS | Graefe hook | Lens expressor | 60 |
| 0108084 | | Bishop Harmon set (bulb & cannula) | Irrigating cornea | 117 |

Extras – the following instruments may be substituted or added to the intraocular set according to surgeon preference and range of surgery performed. For other alternatives please see main catalogue.

| | | | | |
|---------|----|--|----------------------|----|
| 0102011 | SS | Castroviejo needle holder curved, no catch | Fine | 34 |
| 0103106 | SS | Vannas scissors, curved | Ultra fine | 41 |
| 0103105 | SS | Vannas scissors, straight | Ultra fine | 40 |
| 0103085 | SS | Ongs scissors, angled | Capsulotomy | 45 |
| 0109310 | Ti | Chopper extra long | Phaco chop technique | 51 |
| 0109135 | Ti | Weiss standard capsulorhexis forceps | Capsulorhexis | 22 |

Single use items such as swab sticks, drapes and knives are also available from John Weiss please see the Single Use section, pages 121-128 for our full range or contact us at sales@johnweiss.com

Storing your micro instruments in purpose designed trays will protect your investment. See pages 108-110 for the full range of John Weiss sterilisation trays

Single use

Cannulae, Drapes, Sponges, Wipes & Wicks, Eye Shields and Patches, Cautery

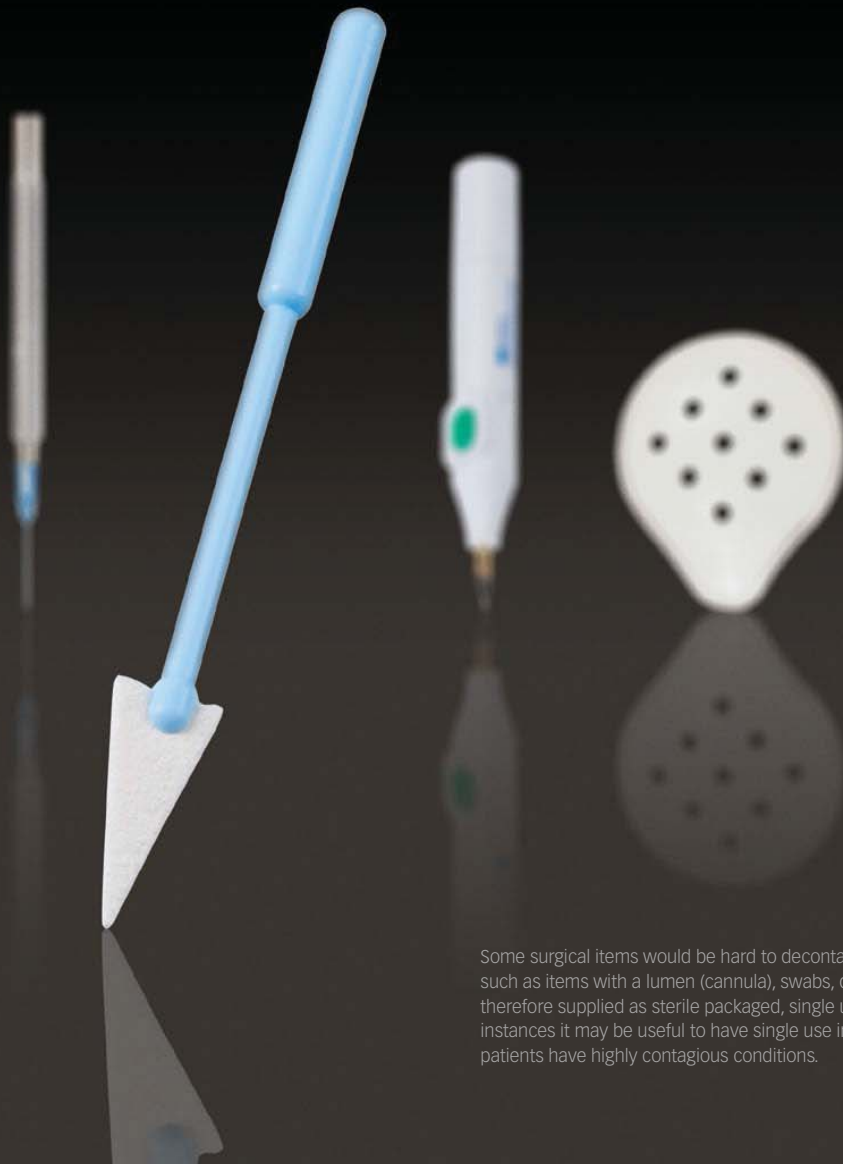

Some surgical items would be hard to decontaminate and re-sterilise such as items with a lumen (cannula), swabs, drapes etc. These are therefore supplied as sterile packaged, single use items. In some instances it may be useful to have single use instruments such as when patients have highly contagious conditions.

Caring for your John Weiss diamond knife – how to use a diamond knife cleaning block

John Weiss diamond knives have the finest surgical cutting edge currently available, however they are extremely delicate and should be handled with great care.*

Normal use does not cause any deterioration of the cutting edge, only incorrect handling, such as letting the knife come into contact with other instruments, may damage it. Take care never to touch the cutting edge as it is extremely sharp. Always keep the diamond retracted in the handle when not in use and during sterilisation.

The use of a diamond knife cleaning block is recommended to remove sticky residue from the blade such as viscoelastic. This should be done as soon as possible after use as it may be difficult to remove once it has dried – a 'dirty' blade may seem blunt.



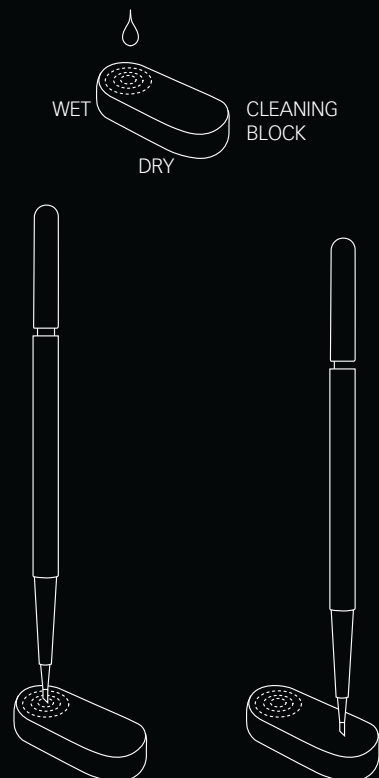

Moisten one end of the diamond knife cleaning block with demineralised or sterile water, leaving one half dry. Carefully stab the diamond blade vertically into the moistened portion several times. Take great care **not to apply any side ways pressure** as that might snap the blade, particularly when cleaning an angled blade. The diamond is now clean and should be gently stabbed vertically several times into the dry portion of the block to dry and polish it – again take care **not to apply any sideways pressure**. Finally retract the diamond into the handle and replace in its tray.

For full guidelines including Ultrasonic Cleaning & Disinfection and Sterilisation, please refer to the '**Care, Maintenance & Reprocessing Guidelines for John Weiss Diamond Knives**' supplied with each new diamond knife and also available to view on www.johnweiss.com

* Please note that the advice given here is intended as a quick guide only and does not replace the validated '**Care, Maintenance & Reprocessing Guidelines for John Weiss Diamond Knives**' supplied with each new diamond knife and available to view at www.johnweiss.com



Cannulae hubs comply with ISO6009 colour coding

| COLOUR |  | GUAGE | ID | | OD | |
|----------------------------|---|-------|-----|--------|------|--------|
| | | | mm | inches | mm | inches |
| Cream |  | 19G | .70 | .028 | 1.10 | .043 |
| Green |  | 21G | .51 | .020 | .80 | .032 |
| Blue |  | 23G | .33 | .013 | .60 | .025 |
| Orange |  | 25G | .25 | .010 | .50 | .020 |
| Brown |  | 26G | .25 | .010 | .45 | .018 |
| Grey |  | 27G | .20 | .008 | .40 | .016 |
| Natural* (clear) |  | 30G | .15 | .006 | .30 | .012 |

*Not an ISO colour code

Cannulae

Sterile. Individually wrapped, 10/box

Gauge Shaft Tip to angle Length*

Anaesthetic

| | | | | | | |
|---------|--|----|----------|--|------|----|
| 0181275 | Retrobulbar Atkinson needle very sharp | 25 | straight | | 38mm | SS |
| 0181637 | Retrobulbar Atkinson needle | 25 | straight | | 38mm | SS |
| 0181638 | Retrobulbar Atkinson needle | 23 | straight | | 38mm | SS |
| 0185027 | Peribulbar Atkinson needle | 25 | straight | | 22mm | SS |
| 0185108 | Peribulbar Atkinson needle | 25 | straight | | 32mm | SS |
| 0185176 | Sub-Tenon's cannula | 19 | curved | | 25mm | SS |

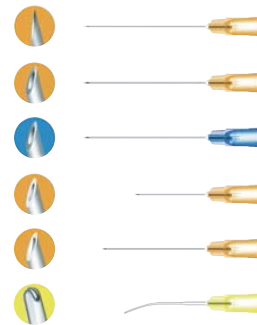

Anterior chamber cannula

| | | | | | | |
|---------|---------|----|--------|-----|------|----|
| 0181273 | Rycroft | 30 | angled | 4mm | 22mm | SS |
| 0181274 | Rycroft | 27 | angled | 4mm | 22mm | SS |



Hydrodissectors

| | | | | | | |
|---------|-----------------------------------|----|--------|-----|------|----|
| 0185037 | Hydrodissector with flattened tip | 25 | angled | 8mm | 22mm | SS |
|---------|-----------------------------------|----|--------|-----|------|----|



Cystotome

| | | | | | | |
|---------|-------------------------|----|--------|--|------|----|
| 0181610 | Cystotome | 25 | formed | | 16mm | SS |
| 0181602 | Cystotome, side cutting | 25 | formed | | 16mm | SS |
| 0181618 | Cystotome | 27 | formed | | 16mm | SS |

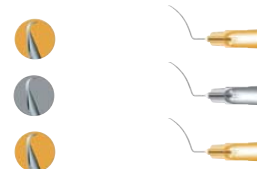

Irrigation/Aspiration

| | | | | | | |
|---------|--------------------------------|----|--------|--|------|----|
| 0185047 | Simcoe 0.3mm port, with tubing | 23 | curved | | 16mm | SS |
|---------|--------------------------------|----|--------|--|------|----|



Lacrimal

| | | | | | | |
|---------|----------|----|--------|--|------|----|
| 0181276 | Lacrimal | 26 | curved | | 30mm | SS |
| 0181615 | Lacrimal | 21 | curved | | 35mm | SS |



* Does not include plastic hub

Cannulae



0108089

Double-ended Cannula holder, straight with 1 x male luer slip connector and 1 x female luer slip connector. Overall length 90mm

REUSABLE



0108222

Simcoe cannula 23G with 0.3mm port. Co-axial, curved, 30mm overall length, comes with tubing and female connector attached

REUSABLE



0108084

Bishop-Harmon topical irrigation set comprising silicone bulb, connector and 19G cannula.

All parts can be purchased separately – as right



0108085

Silicone bulb 55mm x 25mm

REUSABLE



0108087

Connector

REUSABLE



0108083

Bishop-Harmon angled cannula 19G. 6mm tip to angle. Overall length 40mm

REUSABLE



0108088

Southampton angles cannula 19G. 5mm tip to angle. Overall length 50mm

REUSABLE

Drapes

Sterile wrapped 1 drape/packet; 10 packets/box

1601072

Ophthalmic drape, medium, non-woven, incise with bag and wick.

Overall size: W 1300mm x L 1150mm

Incise area: W 100mm x L 80mm

Fluid bag: W 200mm x L 300mm



1601071

Ophthalmic drape, medium, plastic, incise with bag and wick.

Overall size: W 1000mm x L 1270mm

Incise area: W 115mm x L 90mm

Fluid bag: W 530mm x L 300mm



1601095

Ophthalmic drape mini, plastic, incise.

Overall size: W 400mm x L 400mm

Incise Area: W 115mm x L 90mm



Sponges, wipes & wicks

Sterile wrapped



1701002

WeissCEL spears - cellulose spears 7mm x 15mm on sticks. 70mm overall length. 5 spears/packet; 20 packets/box

1701003

WeissCEL spears - cellulose spears 7mm x 15mm on sticks. 70mm overall length. 10 spears/packet; 20 packets/box



0111001

Sugi swabs - cellulose triangles 7mm x 16mm. 10 swabs/packet; 20 packets/box



0111004

Sugi spears - cellulose triangles 7mm x 16mm on sticks. 70mm overall length. 10 spears/packet; 20 packets/box

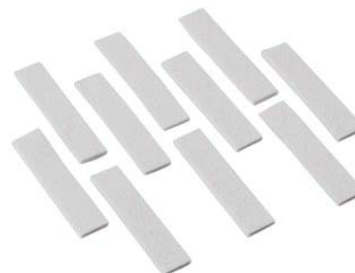

0111008

Sugi strips - cellulose rectangles 7mm x 35mm. 10 swabs/packet; 20 packets/box

Sponges, wipes & wicks

Sterile wrapped

1701006

WeissCEL eye wicks - **fibre free** PVA strip
3mm x 170mm. 2 wicks/packet; 10 packets/box



1701004

WeissCEL eye wick with bag - **fibre free**
PVA strip 3mm x 170mm with 80cc (ml) bag
with adhesive strip. 1 wick & bag/packet;
10 packets/box



1701012

WeissCEL spears - **fibre free** PVA spears
7mm x 16mm on sticks. 70mm overall length.
5 spears/packet; 20 packets/box



1701013

WeissCEL spears - **fibre free** PVA spears
7mm x 16mm on sticks. 70mm overall length.
10 spears/packet; 20 packets/box



1701010

WeissCEL Instrument wipe - **fibre free**
PVA square 64mm x 64mm. 1 wipe/packet;
20 packets/box



1701009

WeissCEL Diamond Knife Cleaning Block -
fibre free PVA block 42mm x 18mm x 10mm.
1 block/packet; 10 packets/box



Eye shields and patches



0111101

Universal eye shield adult, 78mm x 64mm, fits both right and left eye. Sterile, 1 shield/packet; 100 packets/box



0111104

Eye Shield adult, 84mm x 62mm for right eye. Sterile, 1 shield/packet; 100 packets/box



0111105

Eye Shield adult, 84mm x 62mm for left eye. Sterile, 1 shield/packet; 100 packets/box



0120300

Eye patch adult, black silk with elastic, 70mm x 60mm, fits both right and left eye. Non-sterile, 10 shields/box

Miscellaneous

0111122

Weiss cautery, low heat, temperature at activation 704°C (1300°F). Overall length 125mm without cap – 147mm with cap. 1 cautery/packet; 10 packets/box



0120133

Epilation needles straight, 0.125mm x 8mm tip, 20mm overall length, for use with electrolysis unit (unit not available). Sterile wrapped individually, 50/box



INSTRUMENT CARE

Each John Weiss instrument is hand crafted with meticulous care and has to pass a final 100% inspection before being released. By following the Reprocessing Instructions provided with each new instrument and by correct handling, you will protect your investment and ensure that your John Weiss instruments remain in prime condition for many years.

Care of delicate surgical instruments starts on delivery:

Carefully remove your new instruments from their boxes and examine under magnification to be assured they are in perfect condition.* Once you have examined and are happy with the instruments they should be cleaned carefully using specialist instrument wipes (see Single Use section, code No.: **1701010**) and placed in a sterilising tray designed for micro-surgical instruments (see Specialist section for the John Weiss range).

Diamond knives and other specialist instruments may require specific attention – please refer to the separate guidelines which will be provided for these. For the latest information and a copy of our validated Reprocessing Instructions, please refer to the John Weiss website **www.johnweiss.com**

*In the unlikely event that you are unhappy with your instruments in any way, you should notify us immediately on +44(0)1908 340000 or email: sales@johnweiss.com

REPAIRS

Utilising the skills of the instrument maker, John Weiss provides a repair service for damaged or blunt microsurgical instruments. For more information please contact us on +44(0)1908 340000 or email: sales@johnweiss.com